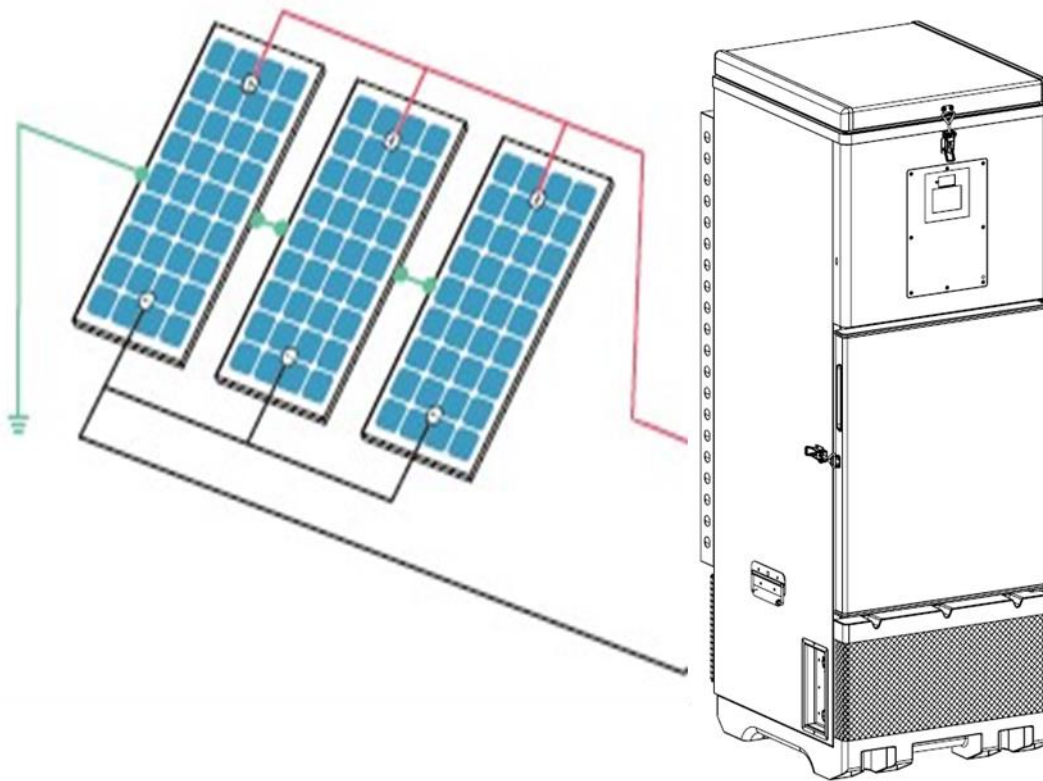


# AUCMA

## MetaFridge<sup>®</sup> CFD-50 SDD

### Solar Power Kit Installation Manual



Please read the manual carefully before use

Keep the manual in a safe place for future reference

Qingdao AUCMA Global Medical Co., Ltd  
ADD: NO.315 Qianwangang Road, Huangdao District Qingdao, China  
Tel: +86-0532-86763602 +86-0532-86762805  
Fax: +86-0532-86763602  
Email: [info@aucma.com](mailto:info@aucma.com)

Rev. 201904

# MetaFridge® CFD-50 SDD Solar Power Kit Installation Manual

## CONTENTS

### INTRODUCTION

STEPS OF A SUCCESSFUL INSTALLATION .....	3
HOW TO USE THE MANUAL.....	4
ABBREVIATIONS.....	4
GLOSSARY.....	4

### PART 1: CFD-50 SDD METAFRIDGE SOLAR POWER KIT DESCRIPTION

- 1A THE SOLAR POWER SYSTEM
- 1B TYPICAL OPERATION
- 1C ELECTRICAL SCHEMATIC DRAWING
- 1D SPECIFICATIONS
- 1E PARTS LIST

### PART 2: PRECAUTIONS

- 2A SAFETY AND SOLAR ELECTRICITY

### PART 3: PRE-INSTALLATION SITE ASSESSMENT

- 3A PRE-INSTALLATION SITE ASSESSMENT GOALS
- 3B CFD-50 SDD METAFRIDGE POSITIONING
- 3C SHADING ANALYSIS AND SOLAR ARRAY SITING
- 3D SOLAR ARRAY CABLE AND GROUNDING SITING

### PART 4: INSTALLATION OF PHOTOVOLTAIC MODULES AND MOUNTING

- 4A PRELIMINARY SITE CHECK
- 4B TESTING SOLAR MODULE PERFORMANCE
- 4C UNIVERSAL MOUNTING STRUCTURE OPTIONS
  - 1.) Sloped roof mounting instructions, flush mount
  - 2.) Sloped roof mounting instructions, tilted mount
  - 3.) Flat roof/ground mounting instructions
  - 4.) Pole mount instructions
- 4D FASTENERS
- 4E GROUNDING THE SOLAR ARRAY

**4F** SOLAR ARRAY CABLE ENTRY TO BUILDING

**4G** PRE-TESTING SOLAR ARRAY AND CONNECTING TO THE METAFRIDGE CFD-50 SDD

**PART 5: INSPECTION, COMMISSIONING, USER TRAINING AND ACCEPTANCE**

**5A** INSTALLATION INSPECTION

**5B** COMMISSIONING

**5C** HEALTH WORKER TRAINING OUTLINE

**5D** ACCEPTANCE

**PART 6: MAINTENANCE**

**6A** USER MAINTENANCE (ROUTINE/PREVENTATIVE)

**6B** TECHNICAL MAINTENANCE (ANNUAL/CORRECTIVE)

**PART 7: TROUBLESHOOTING AND REPAIR**

**7A** SOLAR POWER SYSTEM TROUBLESHOOTING

**7B** SPARE PARTS

**PART 8: WARRANTY**

**PART 9: DISPOSAL AND RECYCLING GUIDE**

**9A** SOLAR POWER SYSTEM COMPONENTS

**REFERENCES and ACKNOWLEDGMENTS**

**ANNEX**

- A. WORKING SAFELY AT HEIGHTS
- B. SITE ASSESSMENT WORKSHEET AND TOOLS LIST
- C. INSTALLATION CHECKLIST
- D. COMMISSIONING REPORT
- E. ACCEPTANCE DOCUMENT
- F. USING MULTI-METERS WITH SOLAR REFRIGERATOR SYSTEMS
- G. HEALTH WORKER QUIZ
- H. USER TRAINING CHECKLIST
- I. MAINTENANCE CHECKLIST
- J. INSTALLATION TOOLS CHECKLIST

## **STEPS OF A SUCCESSFUL INSTALLATION**

This manual will describe how to successfully install and sustain an Aucma CFD-50 SDD MetaFridge Solar Power Kit.

MetaFridge CFD-50 SDD has passed rigorous testing and is undergoing the final steps for prequalification by the World Health Organization's (WHO) Performance, Quality and Safety (PQS) program. CFD-50 SDD is listed in the WHO PQS Catalog with PQS code E003/098.

The Aucma Solar Power Kit complies with the WHO PQS E003 PV01.3 specification.

The Aucma Solar Power Kit is matched to the energy needs of the CFD-50 MetaFridge and you must follow these instructions to assure it will operate correctly for many years.

The general steps of a successful installation are to:

Make sure the site, your crew and you are ready for the installation. See Part 3.

Install the MetaFridge and the Solar Power Kit. See Part 4 (and the MetaFridge Manual).

Commission the entire system and train the users. See part 5.

Maintain - and if needed, troubleshoot and repair. See Parts 6 and 7.

## **HOW TO USE THE MANUAL**

First read the entire Manual.

Remember, always make safety your first priority.

The Aucma Solar Power Kit is complete and usually will have the necessary parts to complete an installation. However, each site is unique and may require a slightly different solution. Therefore, it is strongly recommended that before the installation have a qualified person visit the installation site to make sure the site is ready and all necessary parts, supplies and tools will be available on the site. Then the installation can be completed safely, correctly and in just one installation trip.

The Manual includes detailed Annexes where topics like Working Safely at Heights are described and helpful forms like the Site Assessment Worksheet and Installation Tool Checklist can be copied and used.

Please also refer to the MetaFridge CFD-50 SDD User's Manual and any component specifications included in the solar power kit (e.g. solar modules and mounting structure). If this Manual contradicts product specific instruction please use the product specific instructions and report the contradiction to Aucma at [email: info@aucma.com.cn](mailto:info@aucma.com.cn) or [website: www.aucmaglobal.com.cn](http://www.aucmaglobal.com.cn).

## **ABBREVIATIONS**

**Ω** – Ohms (resistance)

**°C** – degrees Celsius

**DC** – direct current electricity

**°F** – degrees Fahrenheit

**Imp** – solar electric current (amps) at maximum power point

**Isc** – solar electric short circuit current

**LED** – light emitting diode

**PAHO** – Pan American Health Organization

**PQS** – Performance, Quality and Safety program (WHO)

**PV** - photovoltaics

**SDD** – solar direct drive

**UNICEF** – United Nations Children's Fund

**Vdc** – volts (direct current)

**Vmp** – solar electric volts at maximum power point

**Voc** – solar electric open circuit voltage

**W** - Watts

**WHO** – World Health Organization

## **GLOSSARY**

**Acceptable temperature range** – for vaccine storage is between +2°C and +8°C.

**Autonomy** – time in days that a solar refrigerator can maintain the vaccine between +2°C and +8°C acceptable temperature range under low sunlight conditions (e.g. rainy days, night).

**Climate zone** – the highest constant ambient temperature at which a WHO-prequalified vaccine refrigerator can maintain the vaccine storage compartment between +2°C and +8°C.

**Continuity** – a continuous path for conducting electricity.

**Cool down time** – time required for a WHO-prequalified vaccine refrigerator to first reach and sustain the acceptable temperature range between +2°C and +8°C.

**Ground** – connecting the metal components of the solar array to earth with an equipment grounding conductor (ground wire) to a grounding electrode (e.g. ground rod driven in the earth).

**Minimum rated ambient temperature** – the lowest constant ambient temperature at which a WHO-prequalified vaccine refrigerator can maintain the vaccine storage compartment between +2°C and +8°C.

**Multi-meter** – handheld electrical measuring device with settings for volts, amps, ohms (resistance) with other optional readings possible (e.g. temperature).

**Open circuit** – an electrical circuit which has no continuity and thus current cannot flow.

**Open circuit voltage (Voc)** – a solar module or array voltage specification that is measured with no load (amps). Because there is no current flowing, it is an open circuit.

**Orientation** – angle (degrees) a solar array faces in reference to the equator.

**Parallel** – method of connecting solar modules to increase current (amps) without increasing voltage. Positive terminals are all connected to each other and negative terminals are connected to each other.

**Photovoltaics** – the direct conversion of sunlight to electricity.

**Polarity** – measurement of an electrical circuit to determine positive (+) and negative (-).

**PQS** – (Performance, Quality, Safety) A WHO program setting equipment standards and test protocols for vaccine cold chain equipment.

**Resistance** – measurement (Ohms) of the opposition to electrical flow.

**SDD** – solar direct drive refrigerators that do not require a battery for energy storage instead relying on cold mass (e.g. cold water inside the refrigerator walls).

**Service provider** – the person or organization that provides in-country support usually including product storage, transport, installation, user training and post installation support such as troubleshooting, repair and warranty work.

**Shading analysis** – a means of quantifying the impact of obstructions that block sunlight that may reduce the amount and duration of solar array production.

**Short circuit** – improper electrical conducting path when positive (+) and negative (-) conductors connect bypassing a load.

**Short circuit current** ( $I_{sc}$ ) – a solar module or solar array current (amp) specification that is measured with multi-meter set to DC amps and connected across the array terminals, short circuiting them. No load is connected during the test.

**Solar module** – a packaged, connected assembly of solar cells with frame, glass and positive (+) and negative (-) output cables. Also called solar panel, photovoltaic module or photovoltaic panel.

**Solar array** – two or more of solar modules electrically connected together and mounted on a support structure.

**Tilt angle** – angle (degrees) of a solar array as referenced to horizontal.

**WHO** – United Nations organization setting global health standards.

## **PART 1: METAFRIDGE CFD-50 SDD SOLAR POWER KIT DESCRIPTION**

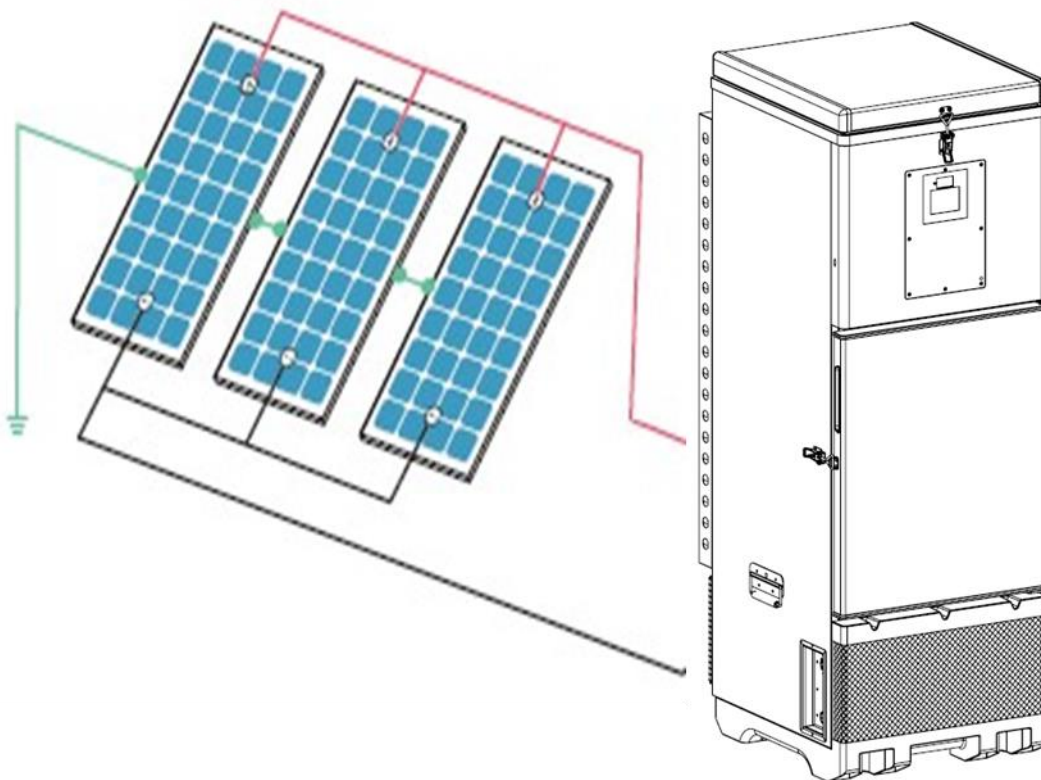
### **1A THE SOLAR POWER SYSTEM**

Photovoltaic (PV) technology uses sunlight to make direct current (DC) electricity. This electricity can directly run the MetaFridge CFD-50 SDD compressor motor.

Known as “solar direct-drive” (SDD), this extremely reliable technology does not rely on batteries to run the compressor. Instead of batteries, energy is stored in the form of cold water and ice within the upper portion of the refrigerator cabinet. An internal heat transfer system surrounds the vaccine compartment with stable, cool surfaces that keep the vaccines in the acceptable temperature range of +2°C to +8°C.

The CFD-50 SDD has just three major parts (see Figure 1.1). They are:

- 1.) Array of connected solar modules to collect and convert solar energy to electricity;
- 2.) Safe electrical wiring and earth grounding; and
- 3.) A vapor compression refrigerator to store vaccines.



**FIGURE 1.1:** *Solar direct drive (SDD) refrigerator system.* Graphic (here and on the cover page) includes elements of graphics courtesy of FGL/IM-PAHO and Solar Electric Light Fund (SELF)

## 1B TYPICAL OPERATION

Solar direct drive (SDD) refrigerators differ from battery-powered refrigerators systems by using solar power to directly freeze water inside the CFD-50 SDD cabinet and then use the store of cold to keep vaccines cool during the night and for 5 days or more with low sunlight (rainy days).

A new CFD-50 SDD installation will take two or three days to freeze enough water to build up sufficient autonomy for safe vaccine storage.

After the initial cool down the operation of an SDD will change depending on the level of sunlight and if the CFD-50 SDD needs more cooling. Typical operation includes:


*Sunny day:* SDD compressor motors can only operate during the day when enough sunlight falls on the solar array. If the CFD-50 SDD thermostat is calling for cooling and enough power is being generated the SDD compressor motor will run and a green LED will be lit.

*Partly cloudy day:* A passing cloud can cause the compressor motor and green LED to turn off temporarily. When the cloud passes and enough sunlight is again available the compressor and green LED will be on again.

*Rainy day:* In cases when it is extremely cloudy or raining the compressor motor and green LED may not come on.

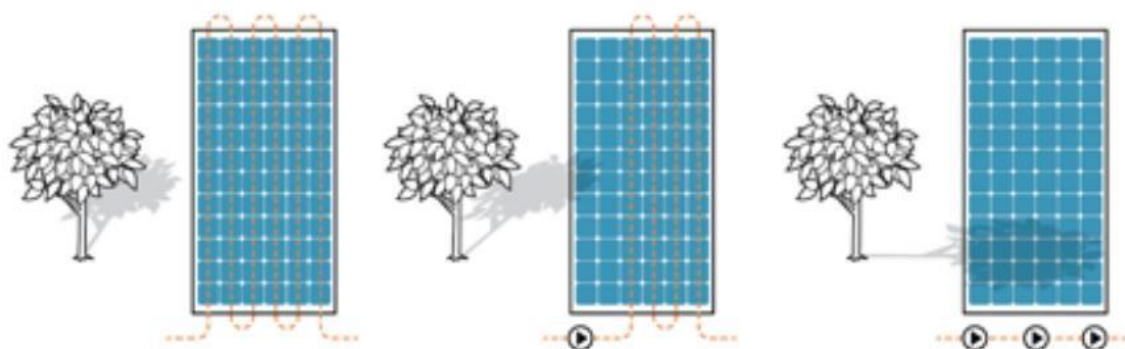
*Night:* At night there is no solar power and the CFD-50 SDD relies on the ice block to keep the vaccines cold. The compressor motor and green LED cannot come on.

The ice block will keep the CFD-50 SDD cold for an autonomy period of up to 5 days at a constant +43°C and can remain cold even longer if the ambient air temperatures are less than +43°C.

 Shading from plants, buildings and other obstructions can stop electricity generation from the solar array.

Dirt and soiling from animals can reduce and even stop electricity generation from the solar array.

It will be important to train the health worker to keep the solar array clean and unshaded. Even small shading and soiling can reduce the amount of electricity from a solar array. See Figure 1.2 for examples of shading losses.



**Figure 1.2:** Shading examples. On the left there is no shading and 100% of the electricity is available. In the middle a small part of the solar module is shaded but 33% of the electricity flow is blocked. On the right where shading crosses the entire solar module all electricity flow is blocked. Graphic courtesy of FGL/IM-PAHO and Solar Electric Light Fund (SELF).



1C

ELECTRICAL SCHEMATIC DRAWING

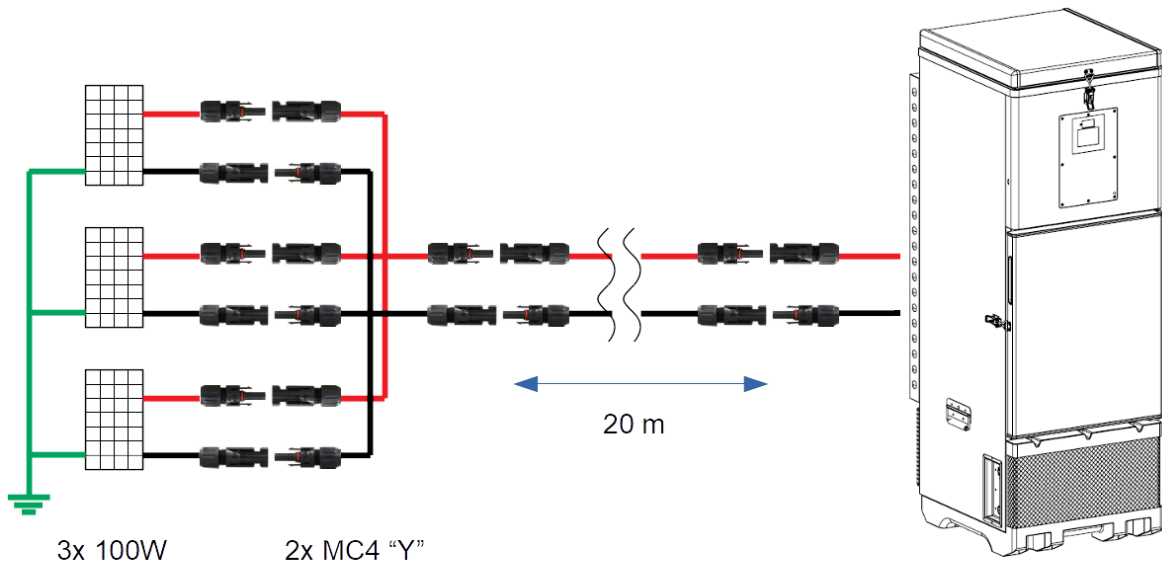


Figure 1.3: Electrical drawing.

1D SPECIFICATIONS

Refrigerator      **MetaFridge CFD-50 SDD**

WHO PQS code      E003/098

Vaccine storage volume      50 liters

Temperature range      +10°C to +43°C

Initial cool down time      2 days of full sun in moderate temperature conditions

Autonomy      120 hours (5 days)

Solar Power System      **Aucma Solar Power Kit**

Solar module (qty 3)      SunDay SDM-100, 100 Watt, 22.44 Voc, 5.69 Imp / 18.05 Vmp, 5.54 Imp

Solar array      300 Watt, 22.44 Voc, 17.07 Isc / 18.05 Vmp, 16.62 Imp

IEC 61215      Yes

Array structure      Aucma Universal Mount Structure (anodized aluminum roof/ground/pole)

Array tilt      Adjustable 0° to 45°

Fasteners      Stainless steel, theft deterrent

Solar array cable      PV Wire, UV resistant, 10 AWG (2.5 mm), 65 feet (20 meters)

Electrical connectors	MC4 “plug and play”, IP67
Ground wire	6 AWG (4 mm) bare copper, 65 feet (20 meters)
Ground rod	9/16” x 4.76 feet (14.2 mm x 1.5 meters), copper clad steel

**1E PARTS LIST**

1. **CFD-50 SDD MetaFridge vaccine refrigerator (1)**
2. **100 W Solar modules (3)**
3. **Solar array cable kit (1)**

Quantity	Part Number	Description
1		20 meter x 10 AWG PV wire with MC4 connectors each end, positive
1		20 meter x 10 AWG PV wire with MC4 connectors each end, negative
1		MC4 branch (“Y”) connector M-F/F/F
1		MC4 branch (“Y”) connector F-M/M/M
		UV resistant nylon wire ties
		Cable clips
		Cable clip fastener sets

**4. Ground wire kit (1)**

Quantity	Part Number	Description
1		20 meter x 6 AWG bare copper wire
1		Ground rod 14.2mm dia x 1.5m long
1		Ground rod connector
3		Lay in lugs for ground wire
3		Lug fastener set (SS bolt, washer split washer, nut)
		Wire clip
		Wire clip fastener set

**5. Universal Mount Structure (1)**

Quantity	Part Number	Description	Item # Roof Dwg.	Item # Pole Dwg.
2	NH-30-00041	Spanning strut. (Weldment, strut, roof mount)	1	
2	NH-30-00045	Module rail. (Weldment, rail)	2	5
6	NH-42-00043	Carriage bolt, 5/16-18 x 3.00, SS18-8	3	6
18	NH-42-00038	Theft deterrent nut (Nut, tamper resistant, 5/16-18, tri groove, SS18-8)	4	7
2	NH-40-00071	Tilt leg. (Strut, solar frame)	5	8
12	NH-40-00028	Clamp, solar frame	7	12

2	NH-30-00040	Crossmember (Weldment, crossmember)		1
4	NH-42-00053	U-Bolt, 4.25 ID x 6.25 L, 3/8-16		2
8	NH-40-00065	Washer, pole mount		3
8	NH-42-00046	Theft deterrent nut for U-Bolt (Nut, tamper resistant, 3/8-16, sloped, plated steel)		4
4		Roof attachment anchors for wood (lag screws)		
4		Roof attachment expansion anchors for concrete		
1		Silicone sealant for roof anchors and wall penetration, tube		


#### 6. Tool kit (1)

Quantity	Part Number	Description
1		Mop for cleaning panels
1		Water bucket for cleaning panels
1		Drivers for theft-deterrent fasteners
1		Hacksaw for tilt leg adjustment

## **PART 2: PRECAUTIONS**

### **2A SAFETY AND SOLAR ELECTRICITY**

Even low voltage solar power installations have hazards.

Always make safety your priority. This symbol -  - is used in this Manual to alert you to safety and performance concerns.

Solar vaccine refrigerators use low voltage direct current (DC) electricity but there are hazards anytime you work with electricity. A solar array will require a secure mounting structure and this often is attached to a roof or tall pole that requires installers to work at heights. Some roof structures are not strong enough to support the weight of the equipment or the weight of the installer.

You will need to know:

- a.) Hazards associated with this work;
- b.) How to use equipment and tools safely;
- c.) Where the first aid kit is located;
- d.) How to safely work at heights; and
- e.) How to safely work with low voltage electricity.

#### **Safety and First Aid**

Know where the first aid kit is located in your vehicle and at the installation site.

Always keep the first aid kit fully stocked.

Always carry a first aid kit when travelling to installation site.


Wear hard hats on work sites.

Know where your co-workers are.

Use the correct eye protection when hammering, drilling and power sawing.

When working in direct sunlight protect yourself with hats, sunglasses and sunscreens, take breaks and drink plenty of water.

#### **Refrigerators**

 All refrigerators are a suffocation hazard for children. Prevent child accidents by keeping children away from the installation site and removing the door when decommissioning.


CFD-50 SDD MetaFridge has refrigerant R600a and R600a is flammable.

CFD-50 SDD MetaFridge can be extremely heavy, especially after it is filled with water.

## Solar Array

Solar modules produce electricity when exposed to sunlight and there is risk of electrical shock.

Do not work on live electrical wiring or parts. Disconnect the solar power input at the CFD-50 SDD “on/off” switch or cover the solar array with opaque material like a blanket, tarp, or cardboard. Then confirm electricity is off with a multimeter.

 Even low voltage will create an arc of electricity that can cause accidents, ignite fires, damage tools and damage the MC4 connectors.


Do not disconnect the “plug and play” MC4 connectors when the solar array is generating electricity.

To stop electricity production cover the solar array with an opaque object.

Do not exceed 22 Voc when connecting solar modules.

Handle with care as most solar modules are made with metal frames with sharp corners and glass covering.

## Working at Heights

 See **ANNEX A: Working Safely at Heights, which was provided courtesy of FGL/IM-PAHO and Solar Electric Light Fund (SELF).**

Ladders must be safe and in good repair.

Position ladders firmly to avoid movement.

Use rope and harness systems.

Use crawling boards when walking on roofs.

If you fall from the roof or ladder do not move until professional help arrives.

For the health worker/user there must be a safe and convenient way to access the solar array for routine cleaning.

## **PART 3: PRE-INSTALLATION SITE ASSESSMENT**

### **3A PRE-INSTALLATION SITE VISIT GOALS**

Each installation site is going to be different. A visit to the site beforehand is recommended. A qualified person can then meet staff, plan for the dates of the installation, assess the health facility building and record the details required to safely and properly complete the installation. The goal is to get enough details to be able to complete the installation safely and professionally in just one trip. The required information (including a tools list) is summarized in **ANNEX B: Site Assessment Worksheet, provided courtesy of World Health Organization (WHO)**.

The Site Assessment Worksheet has 10 sections:

1. Site assessment details (complete before traveling to site)
2. Transportation details (complete before traveling to site)
3. Site survey and assessment tool list (prepare before travel)
4. Facility details
5. Refrigerator placement
6. Solar array siting
7. Solar array cable
8. Ground wire
9. Photographs (as needed)
10. Construction detail sketches (as needed)

Before travelling for the pre-installation site visit complete sections 1, 2 and 3 to get complete directions to the site, prepare transport and assure you will have the needed tools.

Once at the site the assessor interviews the responsible health center worker(s) to find out where to place the various parts of the system and schedule the installation date.

The pre-installation site assessment must be accurate enough to provide information to plan, prepare and later complete the installation. Take the time to carefully observe and make well informed decisions. Anything less may mean delayed vaccination programs, added costs, extra trips, added time, unsafe work conditions and possible improper equipment choices during the installation.

### **3B METAFRIDGE CFD-50 SDD POSITIONING**

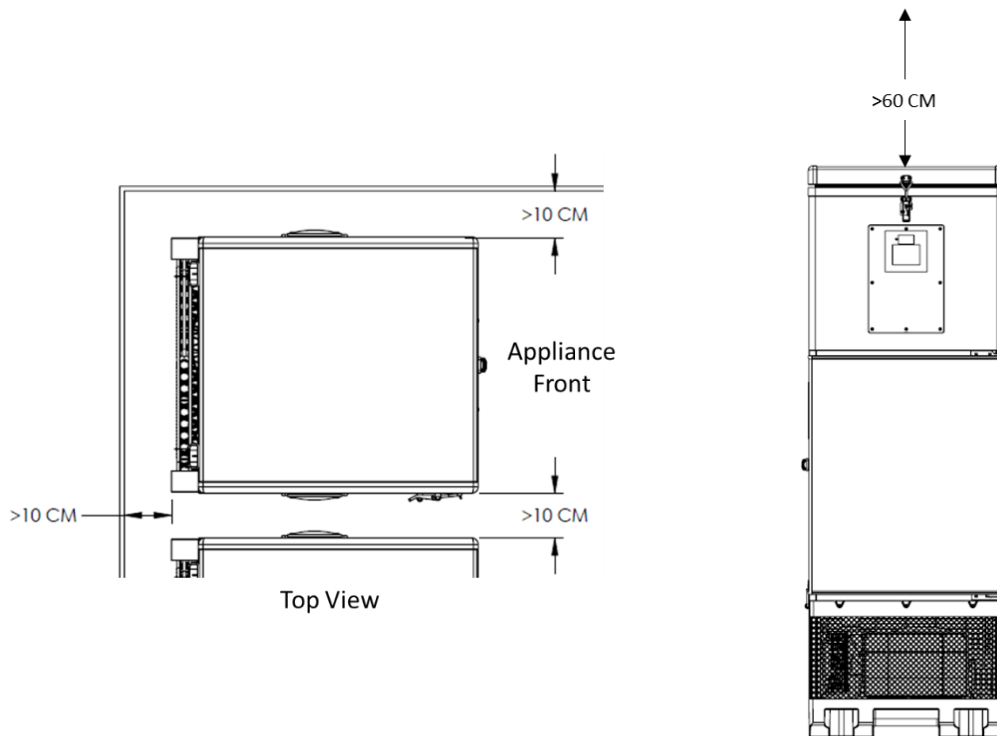
During the pre-installation site assessment meet with the facility staff to discuss CFD-50 SDD MetaFridge location.

Remember the solar array cable will need to enter the facility and then connect with the CFD-50 SDD.

This guidance on positioning the CFD-50 SDD is taken from the refrigerator installation manual supplied with the CFD-50 SDD.

- a. Place the CFD-50 SDD MetaFridge on flat and solid ground and ensure the unit is level.
- b. No pallet is required. CFD-50 SDD has an integrated plastic base.
- c. Position the CFD-50 SDD near where the solar array cable can be connected to the CFD-50 SDD power cord. Its length is about 1 meter.
- d. Position the CFD-50 SDD away from direct sunlight and any source of heat (e.g. gas stove, fireplace, etc.).
- e. CFD-50 SDD must not be placed in or around flammable or corrosive gases that could cause an explosion.
- f. In order to prevent rust or electrical leakage, the CFD-50 SDD should not be placed in a high humidity environment or in a location where it could be splashed with water or rain.

- g. Position the CFD-50 SDD in a well-ventilated area and make sure there is a minimum of 10 cm of empty space around the sides and back of the unit. The door latch must be accessible and the door must be able to open freely to at least 90°.
- h. Allow a minimum of 60 cm clearance above the CFD-50 SDD for accessing the water tank lid.



**Figure 3.1:** *CFD-50 SDD placement.*

### 3C SHADING ANALYSIS AND SOLAR ARRAY PLACEMENT

Solar site analysis is crucial to properly position the solar array. The position of the array is extremely important. Even partial shading of a solar module can nearly stop power output. More power is produced the longer the sun directly shines on the array. A good solar site has no shading and receives direct sunlight from 7AM to 5 PM all year long. It is best to conduct the solar site analysis using a specialized solar siting device like the Solar Pathfinder shown in Figures 3.2 through 3.5.



**Figure 3.2:** *Parts of the Solar Pathfinder where reflections seen on the dome can be traced onto a “sun path” diagram to assess shading impact. Photo courtesy of FGL/IM-PAHO and SELF.*



**Figure 3.3:** Assembled Solar Pathfinder. Photo courtesy of FGL/IM-PAHO and SELF.



**Figure 3.4:** Checking for impact of tree shading at one possible solar array location. A white pencil is used to trace the shading on the black paper "Sun Path" diagram that shows the times of shading by month, time of day and the percentage lost to shading. Photo courtesy of FGL/IM-PAHO and SELF.



**Figure 3.5:** Tracing shows too much tree shading for an SDD. Solar array location can be moved to avoid shading. Photo courtesy of FGL/IM-PAHO and SELF.



When selecting a location for the SOLAR array, consider the following questions:

- Does the array receive direct sunlight from at least 9 AM to 3 PM all year long?
- Is there shading from trees, buildings, pipes or fencing?
- Are there any future changes that may cause array shading (e.g. tree/plant growth)?
- Are there local weather conditions like morning fog or afternoon cloudiness that would limit solar radiation at times of the year?
- Is the array location safe from damage due to wind, animals, people, vehicles or accidents?
- Is theft a concern?
- Can the roof support the weight of the array and the installation crew?
- Will installation damage the building in any way?
- How can solar array cable and ground wire be kept short and neat?
- How will a solar array look at the proposed site?

Refer to **Annex B: Site Assessment Worksheet** and take a blank copy to each site to be visited. Complete all questions before leaving the site. Answer each question thoroughly enough for someone else to be able to adequately prepare for the installation.

### **3D SOLAR ARRAY CABLE AND GROUNDING**

When both the MetaFridge CFD-50 SDD and solar array positions are decided then the solar array cable and ground wire placements can be determined.

The CFD-50 SDD solar power system kit includes a 20 meter solar array cable and a 20 meter ground wire, ground rod and grounding connectors.

Select the route for the solar array cable that is:


- a.) The shortest distance (less than 20 meters) from solar array to CFD-50 SDD (including all bends required to secure cabling to building)
- b.) Safe; and
- c.) Allows the cable to be secured.

Select the route for the ground wire that is:

- a.) The shortest distance (less than 20 meters) from solar array to the earth (including all bends required to secure ground wire to building);
- b.) Safe; and
- c.) Allows the ground wire to be secured.

Note: An alternate ground connection can be made to concrete metal reinforcement bars that are exposed on rooftops or building foundations.

Record the distance of both the solar array cable and ground wire.

 If distances are greater than 20 meters for either solar array cable or ground wire consider moving the solar array or moving the CFD-50 SDD location. If you are unable to re-locate the solar array cable and/or the ground wire and require length(s) greater than 20 meters then a special order will be required to obtain the custom length(s).

**If conduit is required to sheath the cables, be sure to add it to the materials list and obtain it before the installation visit. Conduit is not supplied as part of the installation kit.**


## **PART 4: INSTALLATION**

### **4A PRELIMINARY SITE CHECK**

The solar array location selected in the site visit should be reviewed. Before installing, confirm that:

- 1) Solar array location is correct.
- 2) Solar array will attach to a secure foundation or roof.
- 3) Solar array will face the equator (+/- 20 degrees).
- 4) Solar array tilt angle will be equal to site latitude (and at least 10 degrees from horizontal).
- 5) Solar array will be unshaded between the hours of 9 AM and 3 PM.
- 6) Solar array cable and ground wire of 20 meters (maximum) will be sufficient.
- 7) Health worker will have safe access for washing the solar array.
- 8) Unauthorized persons will not have ready access.
- 9) Theft will be prevented or at least minimized.
- 10) All parts required are on site.

### **4B TESTING SOLAR MODULES**

 Always handle solar modules carefully. The aluminum frame has sharp corners that can cut skin or damage other materials. The cover is made of glass and if cracked or broken the module cannot be installed. Cracked glass can cut skin or other materials.

Open the box carefully. You can use the packaging for protecting the module while handling and for covering the solar array when measuring short circuit current (Isc). Remember to clean up all packaging when completing the installation.

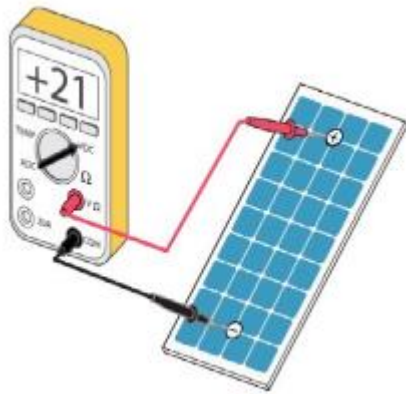
See the label on back of the solar module for the specific ratings of the PV modules provided in the kit. The three most important ratings you will use are:

- 1) Watts;
- 2) Open circuit voltage (Voc); and
- 3) Short circuit current (Imp).

Before installing the modules read the specification. Are the total number of Watts specified in Part 1.D provided? For example, if the system requires 300 Watts and the kit includes three (3) 100 Watt solar modules then you have the 300 Watts required (3 x 100 Watts = 300 Watts).

A typical 100 Watt solar module will be rated at 22 Volts (Voc) and about 5 amps (Imp).

Next measure the open circuit voltage (Voc) of the panels. Prepare your multi-meter to measure DC volts. See Figure 4.1 below. Connect the red lead of the meter to the positive cable of the panel and the black lead to the negative cable of the panel. For more information see **ANNEX F: Using multi-meters with solar refrigerator systems, provided courtesy of FGL/IM-PAHO and SELF.**

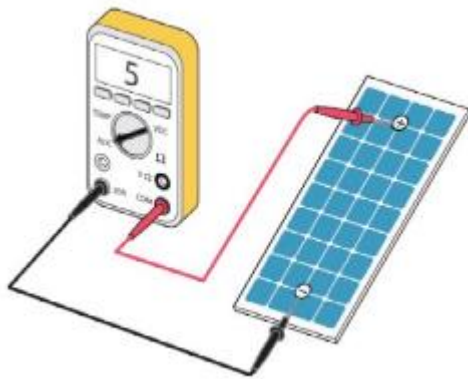


**Figure 4.1** *Measuring  $V_{oc}$  – set multi-meter to measure Volts DC and connect multi-meter to the solar module positive (+) output and negative (-) output. Graphic on left courtesy of FGL/IM-PAHO and SELF.*

Next, measure the module short circuit current (amps).

**⚠** *Always cover the solar module before connecting and disconnecting the meter leads. If uncovered the module will arc electricity and damage the module connections and meter leads.*

The solar module amp specification is based on laboratory tests with full sunlight (for laboratory testing this is 1000 Watts/m<sup>2</sup>). If it is cloudy the amps will be lower than the specification. Figure 4.2 shows the multi-meter settings and measurement points. The table below shows general difference in amps with different sunlight conditions.



**Figure 4.2:** *Measuring  $I_{mp}$  – set meter to measure DC Amps (use 10 or 20 Amp DC range for single panels). Connect multimeter to the solar module positive (+) and negative (-) output. Graphic on left courtesy of FGL/IM-PAHO and SELF.*

## Change of solar module amps with different sunlight conditions

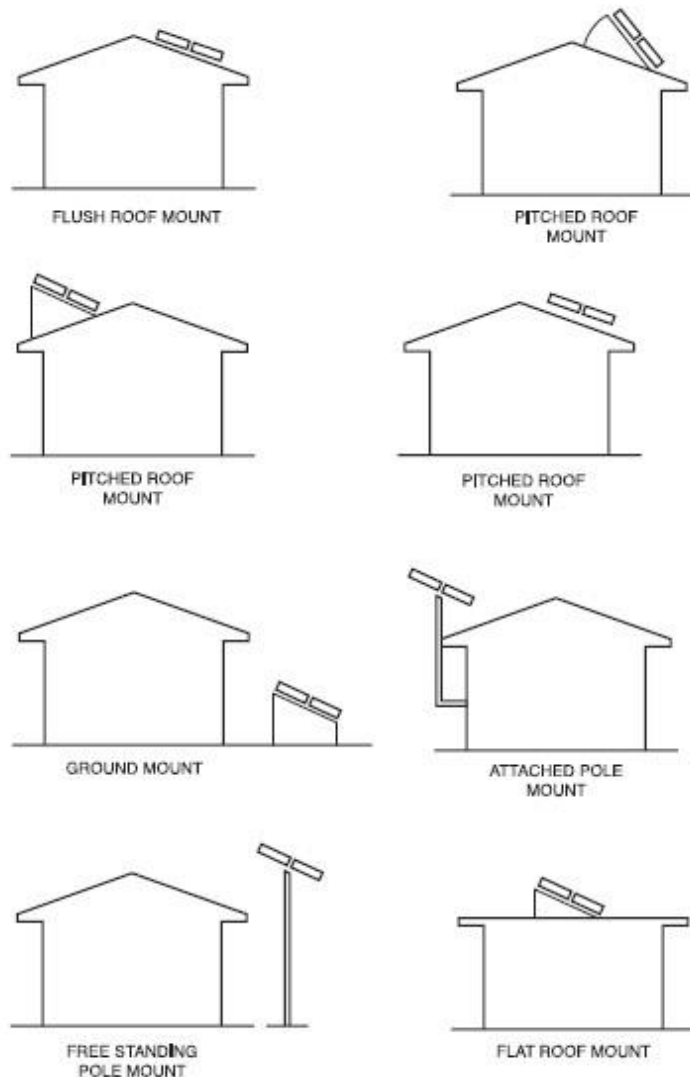
Sunlight Intensity	Output of 100 Watt, 5 amp solar module
Full sunlight – noon, clear day (1000 W/m <sup>2</sup> )	100% of Imp specification (5 amps)
Half sunlight – cloudy day (500 W/m <sup>2</sup> )	50% of Imp specification (2.5 amps)
Low sunlight – rainy day (50 W/m <sup>2</sup> )	5% of Imp specification (0.25 amps)

### 4C UNIVERSAL MOUNT STRUCTURE OPTIONS


The Aucma Solar Power Kit includes the Aucma Universal Mount Structure, the most versatile solar array structure available anywhere because it includes parts for three different mounting options including:


- 1.) Sloped (tilted) roof (adjustable 0 to 45 degrees)
- 2.) Flat roof or ground mount
- 3.) Pole mount (pole and concrete are not supplied).

The Universal Mount Structure can be used for any of the following eight mounting possibilities. See Figure 4.3. Select the version that best matches the site. For tilted roofs, use Section 4C-1. For flat roofs and ground mounts, use Section 4C-2. For pole mount, use Section 4C-3.




**Figure 4.3:** Aucma Universal Mount Structure possibilities. Graphic courtesy of FGL/IM-PAHO and SELF.

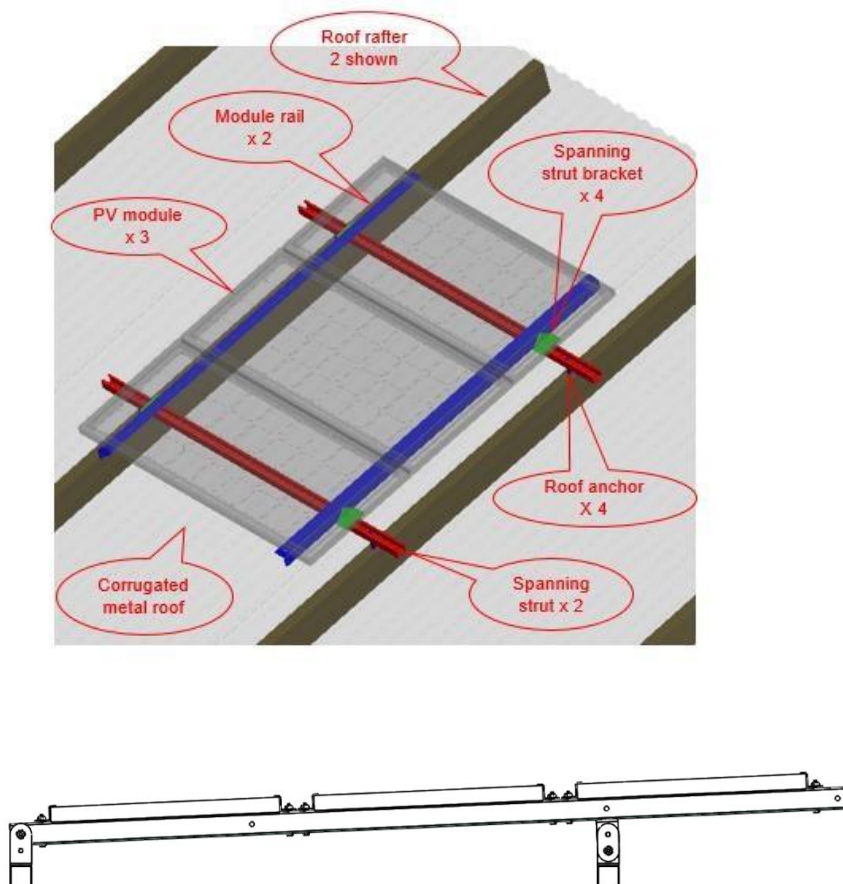
 Solar array mounting structures must be secured to a solid foundation or roof. Accidents can occur on roofs that are not structurally adequate to carry the weight of workers and equipment.

 Solar array mounting structures must be permanently installed to prevent injuries, damage from wind and theft. Solar modules have warranty of 25 years - your work should be for 25 years (minimum) too!

#### 4C-1 Sloped Roof Instructions

The components of the Universal Mount Structure can be used on a sloped (pitched) roof for both flush mounts (see Figure 4.4) and for tilt up mounts (see Figure 4.5). Flush mounts will be parallel to the roof slope. Sloped roof mounts adjust from 0 to 45 degrees.

 Sloped roof installation hazards include working at heights, weak to failing roof structure, slippery roof covering, sharp roof materials, live electric cables, high winds and sunlight glare. To avoid injury from falling tools and parts prevent health workers and patients from access under the roof work area.



**Figure 4.4:** Structural components of the Universal Mount Structure used as a flush mount. Top: transparent view with color-coded components. Bottom: side view of flush mount



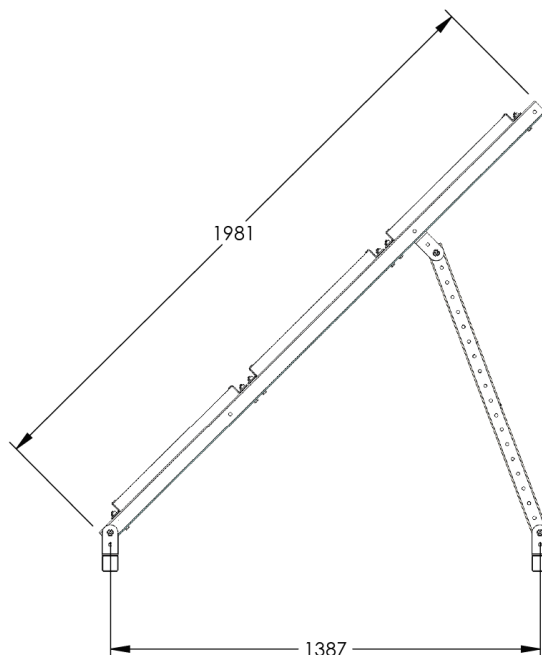
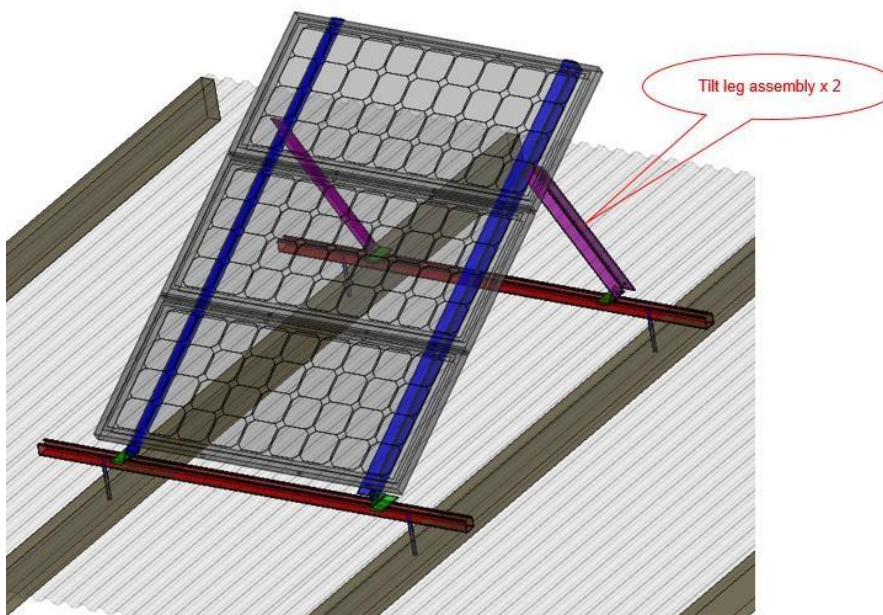
### Positioning a Sloped Roof Mount

**Orientation:** Using your compass, check roof orientation and select a location where the solar array will face the equator. In the northern hemisphere an orientation of  $\pm 20$  degrees of true south is usually acceptable. In the southern hemisphere an orientation of  $\pm 20$  degrees of true north is usually acceptable.

**Tilt angle:** The minimum slope of a solar array is 10 degrees measured from the horizontal to allow rain to drain off the modules while cleaning some dirt and dust. If rain does not drain it can cause mold to grow on the module leading to partial shading and power loss.

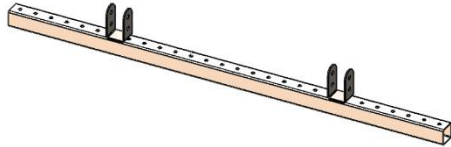
Use an inclinometer (protractor) to measure the roof slope angle. If the pitched roof slope angle is the same as the site latitude and at least 10 degrees then use a flush mount. See Figure 4.11 for how an inclinometer (protractor) can be used to confirm the tilt angle is correct.

The flush mount will place the modules at the same slope as the pitched roof. If the solar array slope needs to be adjusted see the module tilt leg instructions below.



**Figure 4.5:** Tilted roof mount used on an equator-facing sloped roof. The same components from Figure 4.4 are used plus the two rear tilt legs. Top: transparent view with color-coded components. Bottom: side view at about 45 degrees from surface. **Note: Dimensions in mm**

**Spanning Strut Layout:** Position base spanning strut in an east – west direction so that the two fasteners will anchor it into the roof substructure (i.e. beam, purlin or roof rafter as shown above). See Figures 4.4 and 4.6. Secure with theft deterrent bolts supplied. Drill holes through the top of corrugated roofing to prevent roof leaks.



**Figure 4.6:** Base spanning strut.

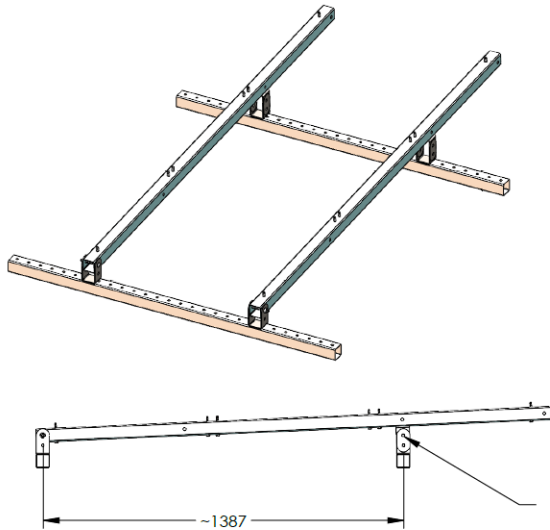
Attach the two module rails to the base strut with carriage bolts and theft-deterrent nuts as shown in Figure 4.7. See the detail of carriage bolt usage also. Do not tighten the fasteners because you will need to move the rails during assembly.



**Figure 4.7:** Attach module rails. *Left: base strut and module rails. Right: carriage bolt detail. Note how square hole prevents carriage bolt from spinning during tightening.*

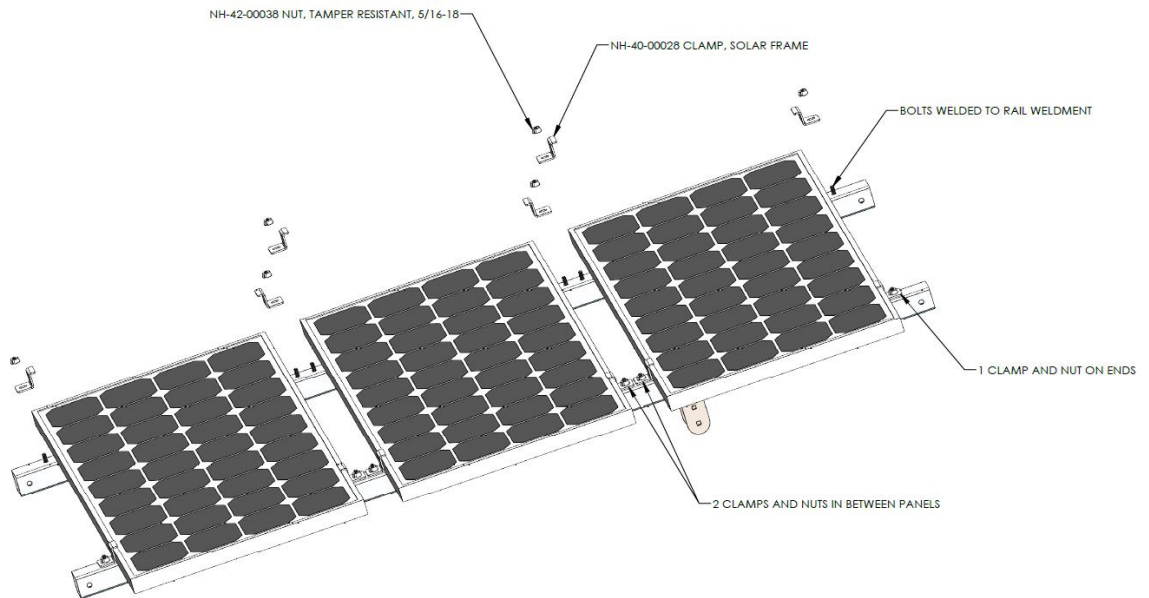
Position the second spanning strut in an east-west direction spaced  $1390\text{ mm} \pm 50\text{ mm}$  from the base spanning strut. For flush mounts, make sure the spacing will allow the welded-on brackets on the rails and the spanning strut to connect. It is recommended that you temporarily connect the second strut to the rails to ensure correct spacing. See Figure 4.8. For tilted mounts, the spacing is a little more forgiving, see Figure 4.5. Secure the strut to the roof with theft deterrent bolts supplied. Seal all roof penetrations with the sealant supplied. Save some sealant for wall penetrations.





**Figure 4.8:** Positioning second spanning strut for flush mount option. Be certain to align the mounting holes as shown by the arrow.

**Module to rail attachment:** Attach the solar modules to the module rail with the theft deterrent fasteners supplied. The top clamp fasteners are theft deterring. See Figure 4.9.



**Figure 4.9:** Top clamp details.

**Module ground connections:** With the module glass protected and facing down (the assembly has been removed from the spanning struts), attach one ground lug to each module in the ground lug hole on the module frame. See Figure 4.10.

For flush mounts you must now attach the 20 meter ground wire that will later connect to the earth ground rod. Set the free wire aside.

For tilt up mounts the ground wire step can optionally be delayed if it is more convenient to complete after the mount and tilt legs are secured.



**Figure 4.10:** Solar module ground lug, fastener and ground wires connected. Photos courtesy of FGL/IM-PAHO and SELF.

**Module output cable connections:** Continue with the module glass protected and facing down. Attach the solar module positive (+) output cables in parallel using the MC4 positive (+) branch connector supplied. All module positive output cables are connected together now. Next attach the solar module negative (-) output cables in parallel using the MC4 negative (-) branch connector supplied. All module negative output cables are connected together now. See Figure 4.11.

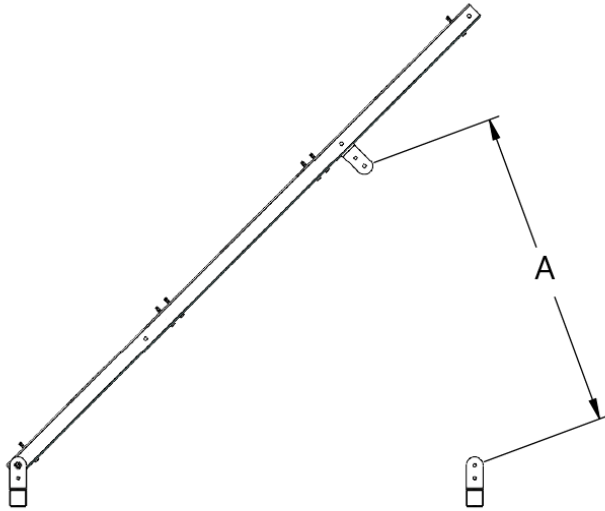
For flush mounts now you must attach the 20 meter solar array cable to the MC4 branch connectors that will connect to the CFD-50 SDD and tie any loose cables with the UV resistant, black nylon cable ties supplied. Set the solar array cable aside. For mounts that will use the tilt leg this step can optionally be delayed if it is more convenient to complete after the tilt legs are secured to the module rails.



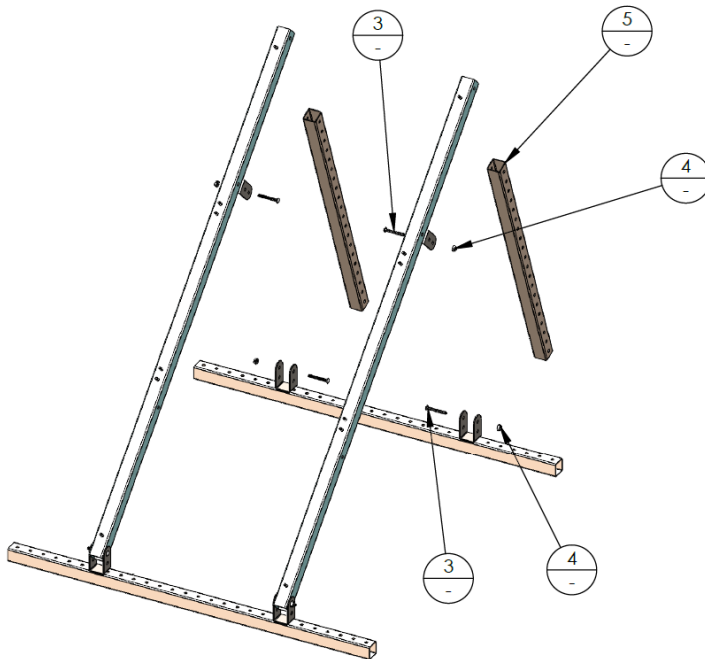
**Figure 4.11:** Branch connectors for joining three solar modules in parallel with positive (+) output to the left. Note careful wire management has tied loose wires. Photos courtesy of FGL/IM-PAHO and SELF.

**Flush mount:** Attach module rails to strut brackets with carriage bolts and theft-deterrent nuts.

**Tilt leg:** Tilt up solar arrays will use the strut brackets (2) at the base spanning strut to attach the tilt legs. Tilt legs must provide the correct tilt angle by attaching to brackets welded to the module rail. Test the assembly using the inclinometer to confirm the correct angle is found. In some cases the tilt legs may need to be cut and then attached to the module rails to achieve the correct tilt angle. Loosely attach both tilt legs to the spanning strut bracket and then carefully raise the solar array and attach tilt legs to the module rails. Fasten securely with the theft deterrent fasteners supplied.



**Figure 4.12:** Determine distance “A” between holes in strut that gives the proper tilt.




**Figure 4.13:** Assemble tilt legs (5) using carriage bolts (3) and theft-deterrent nuts (4). Modules not shown for clarity.

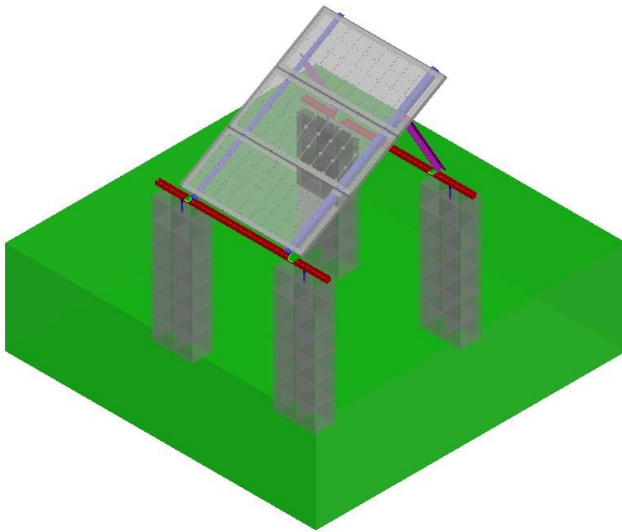
**Tighten all fasteners:** Once the structure with solar modules has been positioned retighten all theft deterrent fasteners.

#### 4C-2 Flat Roof /Ground Mount Instructions


Flat Roof/Ground Mount use the same components as the Pitched Roof Mount (see 4C-1). The only differences are the fasteners that attach the spanning struts to the concrete foundation or concrete roof. See Figure 4.3 for flat roof or ground mount options adjustable up to 45 degrees. Select the version that best matches the site.

Ground mounts are not used often because they are the most expensive option, require significant concrete foundations, underground conduit or overhead cable and usually require a security fence to prevent people, vehicles and animals from contacting the solar array. Theft is less preventable since the solar array is easy to see and easy to access.

 Flat roof installation hazards include working at heights, weak to failing roof structure, slippery roof covering, sharp roof materials, live electric cables, high winds and sunlight glare. To avoid injury from falling tools and parts prevent health workers and patients from access to under the roof work area.



**Figure 4.14:** *The Aucma Flat Roof Mount can also be used as a Ground Mount.*

 Ground mount installation hazards include open foundation excavations and open conduit trenches.

Prevent health workers, patients, vehicles and animals from access to the ground mount work area to avoid injury from falls and encountering the sharp metal corners of the solar array.

#### **Positioning a Flat Roof/Ground Mount**

**Orientation:** Using your compass, check orientation and select a location where the solar array will face the equator. Ground mount installation will require a concrete foundation to be built. This manual does not detail concrete construction techniques required for the foundation. See a construction manual for concrete forming, mixing, pouring and curing requirements.

**Tilt angle:** The minimum slope of a solar array is 10 degrees measured from the horizontal to allow rain to drain off the modules while cleaning some dirt and dust. If rain does not drain it can cause mold to grow on the module leading to partial shading and power loss. See Figure 4.15 for how an inclinometer (protractor) can be used to confirm the tilt angle is correct.



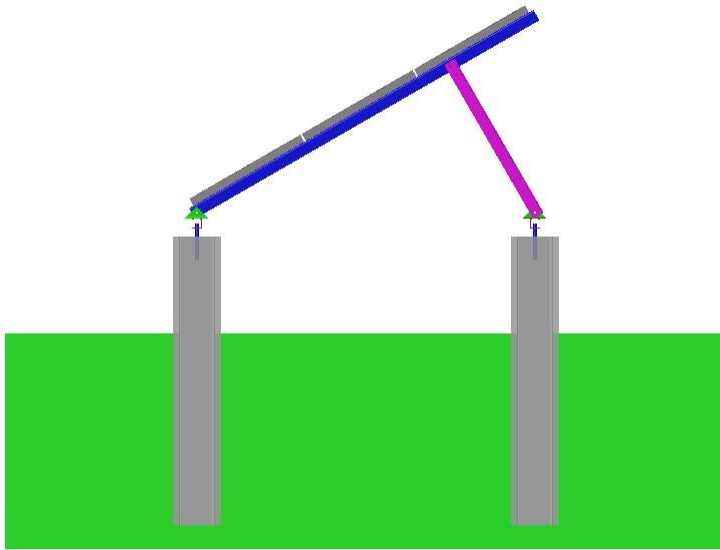
**Figure 4.15:** An inclinometer (protractor) can be used to confirm the tilt angle is correct. Photo courtesy of FGL/IM-PAHO and SELF.

**Spanning Strut Layout:** Position base spanning strut in an east – west direction so that the expansion anchor fasteners holes can be drilled to attach the spanning strut to the concrete roof substructure (or for Ground Mount attach spanning strut to the anchor bolts used in the concrete foundation). Position the second spanning strut in an east-west direction spaced 1390 mm  $\pm$ 50 mm from the base spanning strut. See Figure 4.5 for spacing. Secure with theft deterrent nuts supplied. Seal all expansion anchor holes with sealant supplied. Save some sealant for wall penetrations.

**Module rail:** At the base spanning strut attach the module rail to the strut bracket as in Figure 4.7 using carriage bolts and theft-deterrent nuts. Repeat for the second module rail. Do not tighten fasteners yet.

**Tilt leg:** Tilt up solar arrays will use two strut brackets at the second spanning strut. Tilt legs must provide the correct tilt angle by attaching to in the brackets welded to the module rail. See Figure 4.12. Test the assembly using the inclinometer to confirm the correct angle is found. In some cases the tilt legs may need to be cut and drilled and then attached to the module rails to find the correct tilt angle. Loosely attach tilt legs to the spanning strut bracket and then attach to the module rail; see Figure 4.13. Fasten securely with the theft deterrent fasteners supplied.

**Module to rail attachment:** See Figure 4.16 for side view of a Ground Mount. Begin with the solar module (#1) at the lowest position and attach with clamps. Tighten clamps to hold module level and firmly in place. The next module (#2) will attach between modules #1 and #3. Tighten mid clamps. Module #3 attaches at the top. Tighten all clamps. See Figure 4.9.



**Figure 4.16:** *Ground mount and concrete foundation. Flat concrete roof installations can attach to the concrete roof directly or an added foundation can be cast on top of existing roof.*

**Module ground connections:** Attach one ground lug to each module in the ground lug hole on the module frame. Connect ground wire starting at the module farthest from the ground rod location and feed the wire through each module. Set the ground wire aside. See Figure 4.10.

**Module output cable connections:** Attach the solar module positive (+) output cables in parallel using the MC4 positive (+) branch connector supplied. All module positive output cables are connected together now. Next attach the solar module negative (-) output cables in parallel using the MC4 negative (-) branch connector supplied. All module negative output cables are connected together now. See Figure 4.11.

Attach the 20 meter solar array cable to the MC4 branch connectors that will connect to the CFD-50 SDD and tie any loose cables with the UV resistant, black nylon cable ties supplied. Set the array cable aside.


**Tighten all fasteners:** Once the structure with solar modules has been positioned retighten all theft deterrent fasteners.

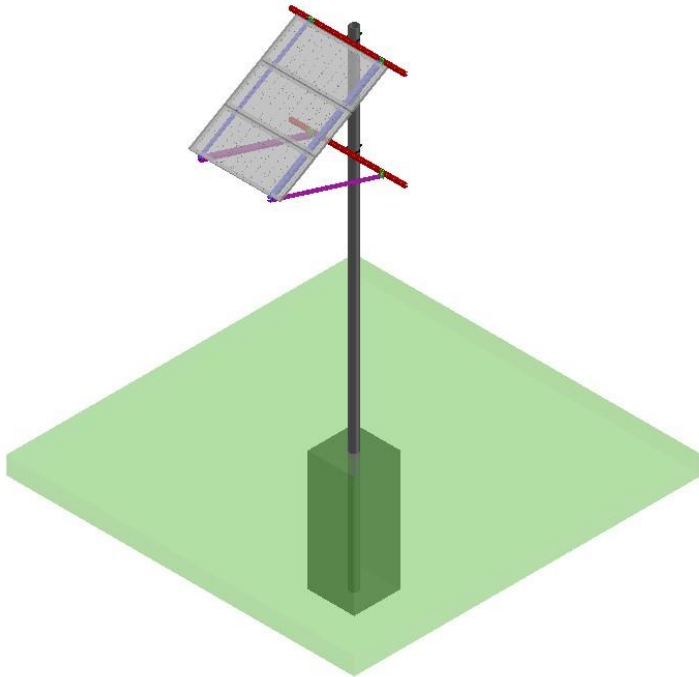
#### **4C-3 Pole Mount Instructions**

Pole mounts are used when the roof is not suitable because of shading, weak structure or theft concerns. See Figure 4.3 for two pole mount options. Select the version that best matches the site.


Side of pole mount uses the same Universal Mount Structure components with different struts plus four U-bolts (see Figure 4.18).

Note that the Aucma Universal Mount Structure used for pole mount will require that you obtain a pole and foundation materials for a free standing pole or customized wall attachments for building attached poles. Conduit is recommended for protecting the solar array cable and usually must be buried underground with a free standing pole. Conduit is not included with the Aucma Solar Power Kit.

 Pole installation hazards include heavy weight of the pole, working at heights, high winds and sunlight glare. Freestanding poles require foundation and underground conduit excavations. To avoid injury from falling tools and parts prevent health workers and patients from access under the pole work area.



**Figure 4.17:** *Free standing pole mount and concrete foundation.*

 Free standing pole mount installation hazards include open foundation excavations and open conduit trenches. Prevent health workers, patients, vehicles and animals from access to the pole mount work area to avoid injury from falls.


#### **Positioning a Pole Mount**

**Orientation:** Using your compass, check orientation and select a location where the solar array will face the equator. Free standing pole mount installation will require a concrete foundation to be built. This manual specifies the depth and diameter of the foundation but does not detail concrete construction techniques required for the foundation. See a construction manual for concrete forming, mixing, pouring and curing requirements.

**Pole: free standing pole/foundation or building attached pole requirements:** The following components are not included in the Aucma Solar Power Kit and will be obtained locally:

Pole: 4" x 20' Schedule 40 galvanized steel pole. Preferably threaded with 1 end cap used at top.



 A 4" by 20' (10 cm by 6 meter) schedule 40 galvanized steel pole can weigh over 220 lbs. (100 kg).

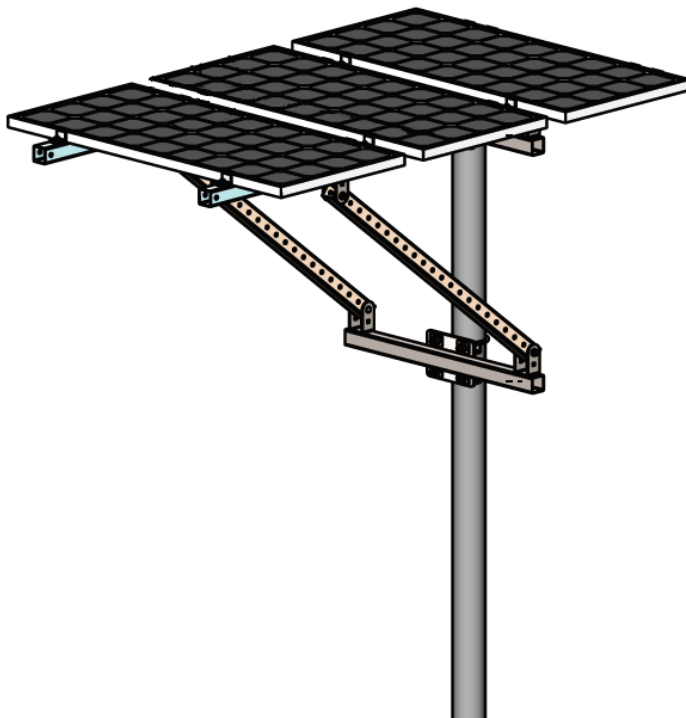
Foundation: Concrete, 4' (1.22 m) deep by 2' (0.6 m) diameter requires approximately 1 cubic yard (0.75 cubic meter).

Wall attachment: This is a customized option and must be engineered. Use welded attachment fittings, hot dipped galvanized (recommended) or zinc painted. Stainless steel or galvanized steel fasteners must be theft deterring.

Conduit and supports: As needed. All metal to be stainless steel or galvanized steel.

**Freestanding pole placement:** Dig foundation, form and place pole in hole. Use three wood braces to hold pole in place while pouring concrete. Minimum recommended size for braces is 2" x 4" x 8' to 10' (100mm x 50 mm x 2.5 to 3 meters) staked in a tripod pattern and wired to pole. Pour concrete and allow to harden overnight.

**Set up scaffold:** Scaffold is the safest, most convenient way to install a free standing pole mount. See ANNEX A: **Working Safely at Heights- Scaffold Safety.**



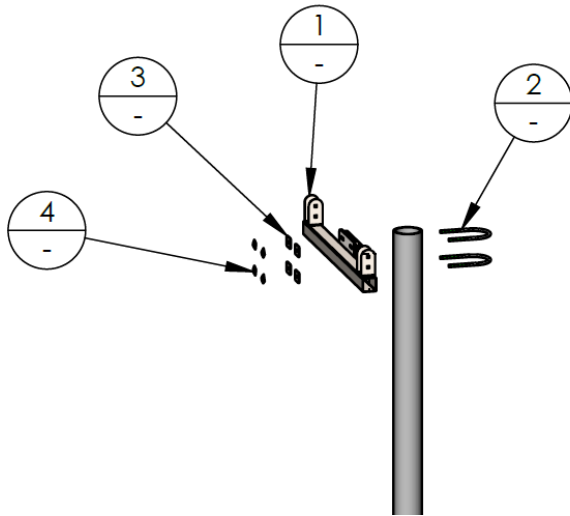
**Figure 4.18:** Pole mount structure uses four U bolt pipe clamps for attachment to the pole (approximately flat example).

**Tilt angle:** The minimum slope of a solar array is 10 degrees measured from the horizontal to allow rain to drain off the modules while cleaning some dirt and dust. If rain does not drain it can cause mold to grow on the module leading to partial shading and power loss. See Figure 4.15 for how an inclinometer (protractor) can be used to confirm the tilt angle is correct.

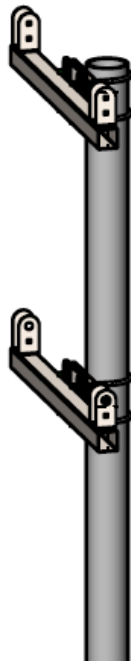
**Crossmember Layout:** Thread on cap at top of pole to keep pole from filling with rain water. Attach top crossmember (1) to pole with two U-bolts (2), four pole mount washers (3), and four theft-deterrent nuts (4). Position top crossmember in an east – west direction so that the U-bolts hold the



strut level and near the pole top. See Figure 4.19. Position lower crossmember in an east-west direction, level and spaced 760 mm  $\pm$ 25 mm from the top crossmember. See Figure 4.20.

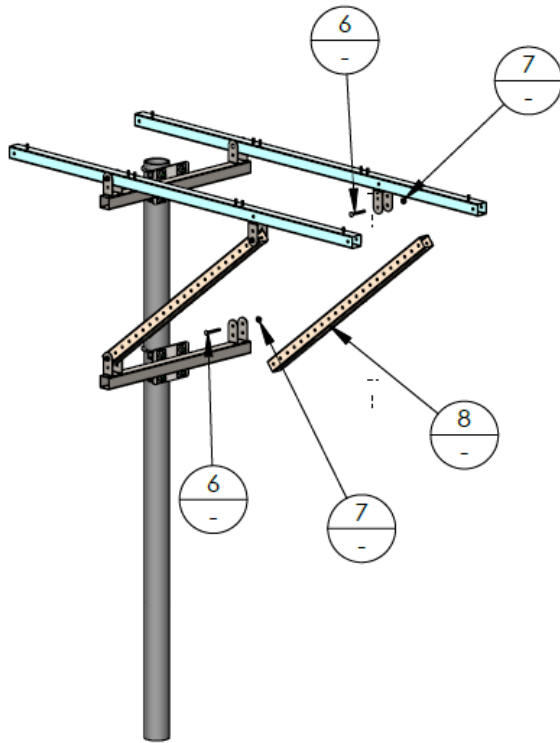


**Figure 4.19:** Assemble top crossmember.



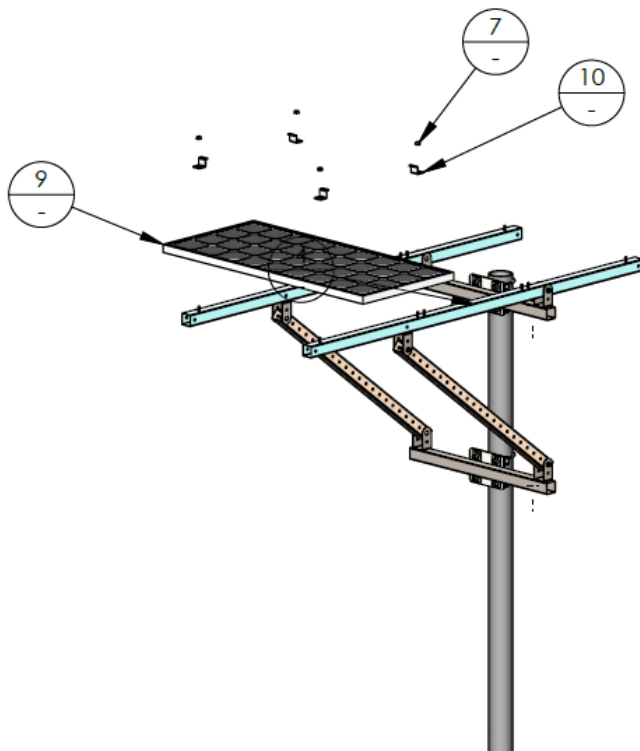
**Figure 4.20:** Assemble lower crossmember 762 mm below the first (center to center).

**Module rail and tilt leg:** Attach module rail (5) to top crossmember using carriage bolts (6) and theft-deterrent nuts (7). Then attach module rail to tilt leg(8). Finally attach tilt leg to lower crossmember bracket. Confirm correct orientation with compass and confirm correct tilt angle with inclinometer (protractor). Tighten all theft deterring fasteners. Repeat for the second module rail. See Figure 4.21.



**Figure 4.21:** Assemble module rails and tilt legs to crossmembers.

**Module to rail attachment:** Begin with the solar module (#1) at the lowest position and attach at bottom with clamps. Tighten clamps (10) with theft-deterrent nuts (7) to hold module level and firmly in place. The next module (#2) will attach with clamps between modules #1 and #3. Tighten clamp. Module #3 attaches at the top. Tighten all clamps. See Figure 4.22 for first module assembly and Figure 4.9 for detail on the clamps.



**Figure 4.22:** Assemble modules to module rails (first module shown).

**Module ground connections:** Attach one ground lug to each module in the ground lug hole on the module frame. Connect ground wire starting at the module farthest from the ground rod location and feed the wire through each module.

Feed the ground wire along the outside of the conduit used for the solar array cable. Secure with the cable ties provided. See Figure 4.10.

**Module output cable connections:** Attach the solar module positive (+) output cables in parallel using the MC4 positive (+) branch connector supplied. All module positive output cables are connected together now. Next attach the solar module negative (-) output cables in parallel using the MC4 negative (-) branch connector supplied. All module negative output cables are connected together now. See Figure 4.11.

Attach the 20 meter solar array cable to the MC4 branch connectors that will connect to the CFD-50 SDD. Feed the solar array cable through the top of the conduit electric service entrance through the conduit into the building. Tie any loose cables with the UV resistant, black nylon cable ties supplied.

**Tighten all fasteners:** Once the structure with solar modules has been positioned retighten all theft deterrent fasteners.

#### **4D THEFT DETERRENT FASTENERS**

If the solar array is stolen the lives of the community are threatened and valuable vaccine will be spoiled. The Aucma Solar Power Kit includes theft deterrent fasteners and unique tools (see Figure 4.23):



**Figure 4.23:** *Theft deterrent carriage bolt, security nut, and security nut socket driver*

#### **4E            GROUNDING THE SOLAR ARRAY**

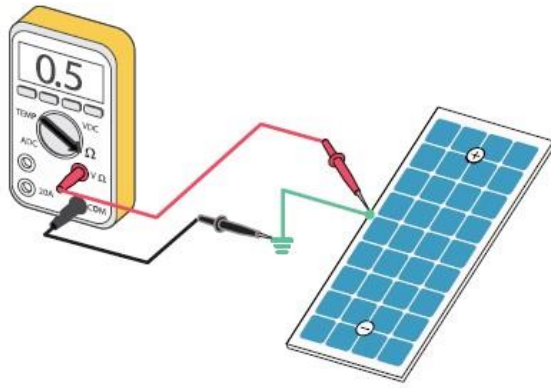
Each solar module is required to be grounded to an earth rod or steel foundation reinforcement rod. Most DC electrical systems are attached with bare copper ground wire to an 8' (2.4 m) copper clad steel rod driven into the earth. The ground wire should take the shortest distance to earth and avoid bends as much as possible. The wire must be secured to the building or pole. Consider conduit protection where it is likely that health workers, patients, children or animals will come intact with the ground wire.

See Figure 4.10 for module to module ground connections. See Figure 4.24 for details of the ground wire to ground rod connection.



**Figure 4.24:** *Ground wire, connector and 8' (2.5 m) copper plated steel rod. Photo courtesy FGL/IM-PAHO and SELF*

To be sure the solar array ground has continuity set your multi-meter to Ohms ( $\Omega$ ) and measure from the farthest solar module frame to the ground rod. The resistance should be 0.5 Ohms or less. See Figure 4.25. Record the resistance in the Commissioning Report. See **ANNEX F: Using Multi-Meters with Solar Refrigerator Systems.**



**Figure 4.25:** *Measuring ground system continuity.* Graphic courtesy FGL/IM-PAHO and SELF.

#### **4F CABLE ENTRY INTO THE BUILDING**

The solar array cable is designed for direct exposure to sunlight. However the cable should not lay in wet areas and the cable should be protected from abrasion, sharp edges, animals and accidental cutting. Electrical fittings are provided to protect the cable where it enters the building. Sealant is provided to weatherproof any penetrations in the building roof and walls.

Some installations will route the solar array cable over the roof edge and through the wall. The cable must be protected against damage and sharp bends at roof edge and when passing through walls. Conduit body boxes can be used to pull wire through sharp bends. Cable entering the wall often make a sharp turn and then pass through the wall. Walls may settle and pinch cables. Rodents can chew through cable insulation.

Conduit protection is one acceptable method to protect cable when entering through a wall. See Figures 4.26 and 4.27.



**Figure 4.26:** *Flush mount solar array with cable entry through electrical service entrance and then through the wall of the health facility.* Photo courtesy of FGL/IM-PAHO and SELF.



**Figure 4.27:** Example of exterior conduit with conduit body and short conduit passing through the wall where the solar array cable is in the health facility. Photo courtesy of FGL/IM-PAHO and SELF.

Alternately, a direct penetration through the roof surface can be made as shown in Figure 4.28. For direct penetration you will need a special component roof flashing (not included in the Aucma Solar Power Kit). Follow the roof flashing instructions carefully to avoid leakage.



**Figure 4.28:** Roof flashing with gasket (not part of the Aucma Solar Power Kit). Photo courtesy of FGL/IM-PAHO and SELF.

#### **4G PRE-TESTING SOLAR ARRAY AND CONNECTING TO THE METAFRIDGE CFD-50 SDD**

Test the solar array cable for polarity and Voc before connecting it to the CFD-50 SDD. Make sure the positive (+) solar array cable MC4 connector will match the red SDD positive (+) input cable / connector Record in the **ANNEX D: Commissioning Report**.

The Voc of an Aucma solar array will usually be between 17 and 22 Vdc (depending on the temperature of the solar module). Record the solar array Voc in the Commissioning Report.

The Isc of a 300 Watt solar array will be about 15+ amps (at midday if weather is sunny and clear). In order to safely measure the Isc of the whole array your multi-meter must have a 20 Amp (DC) setting. Cover the solar array, connect the meter leads to the MC4 connectors, remove the cover, record the amps, cover again and then remove the multi-meter leads. If you have a hand-held solar radiation meter measure solar radiation (instant reading of Watts/m<sup>2</sup>) at the same time as you measure the Isc. Record the solar array Isc (and the optional solar radiation measurement) in the Commissioning Report.

If the ground resistance is 0.5 Ohms or less, the polarity is correct, the Voc is between 17 and 22 Vdc and the Isc is reasonable for the sunlight conditions then the solar array is wired correctly. Congratulations!

With the CFD-50 SDD power switch (located at the rear of the CFD-50 SDD) the “Off” position connect the solar array cable to the CFD-50 SDD cables.

To start the CFD-50 SDD first follow all instructions in the **MetaFridge CFD-50 SDD User’s Manual**.



## **PART 5: INSPECTION, COMMISSIONING, USER TRAINING AND ACCEPTANCE**

### **5A INSPECTION CHECKLIST**

After you have completed the installation fill out the inspection checklist to document that the installation is complete and correct per WHO PQS requirements. If you discover any aspects of the installation that were not completed this is the time to finish the work. See **Annex C: Installation Checklist, provided courtesy of the World Health Organization (WHO)**.

### **5B COMMISSIONING REPORT**

The commissioning report documents the refrigerator temperatures and electrical measurements you have taken including CFD-50 SDD temperature, polarity confirmation, ground system resistance, solar array Voc and solar array Isc. It is the record of how the entire system performs at the completion of the installation. See **ANNEX D: Commissioning Report**.

### **5C HEALTH WORKER TRAINING OUTLINE**

**For:** Day-to-day users of the MetaFridge CFD-50 SDD (health workers and their direct supervisors).

**Goal:** Certify that each user has successfully learned about the new equipment and is prepared to safely use it, to maintain it, record basic information on operation and to understand when to report equipment problems.

**Outcome:** Certificate of Successful Completion awarded to health workers participating in hands-on activities and (optionally) passing a short test.

#### **Suggested Course Outline:**

1. Solar energy basics
2. Battery-free solar direct drive refrigeration
3. Aucma Solar Power Kit
  - Parts – solar array, structure, solar array power cable, ground wire
  - Operations – cool down, sunny day, cloudy day, rainy day and night
  - Autonomy
  - Maintenance
4. Cold chain basics
  - Refrigerator safety
  - Refrigerator placement
  - Keep vaccine +2°C to +8°C
  - Do not use refrigerator for any other purpose
5. CFD-50 SDD MetaFridge refrigerator
  - Parts
  - Operations
  - Daily temperature measurements and recording
  - Energy Harvesting
  - Maintenance

Annex G: Health Worker Quiz

Annex H: User Training Checklist



## **Lesson Plan**

**GOAL:** Staff is comfortable with the solar power equipment, can safely operate and maintain it and know who to report to if there is a problem

**Training materials:**

- a.) MetaFridge CFD-50 SDD and Aucma Solar Power Kit (installed).
- b.) Cleaning supplies and tools.
- c.) Contact details for authority to whom problems must be reported (determine this in advance of the training).

**OBJECTIVE 1:** After a brief introduction the user can identify the components of a solar powered direct drive system and describe how each system functions.

**Task:** Present and describe the components – solar array, structure, array cable, ground wire and CFD-50 SDD.

**Outcome:** Upon successful completion the user will be able to name the main components.

**Evaluation:** Informal, do as a class exercise by asking for a volunteer to name the CFD-50 SDD and point to and name the components of a solar direct drive power system.

**OBJECTIVE 2:** Describe typical daytime operation of a solar direct drive refrigerator – sunny day, cloudy day, rainy day and night.

**Task:** Describe why the fan and or compressor may go on and off with passing clouds.

**Outcome:** Upon successful completion the trainee will describe the weather conditions that can cause the fan and/or compressor to cycle on and off.

**Evaluation:** Informal: Announce that the test will have a question asking what causes the fan and/or compressor to cycle on and off. Ask for a volunteer to answer this question.

**OBJECTIVE 3:** Recognize the impact of shading and soiling on a solar direct drive system.

**Task:** Describe the impact of shading and soiling. Alternately demonstrate shading impacts by partially shading the solar array when the compressor is running. The shading will turn off the compressor or slow its speed.

**Outcome:** Upon successful completion each student will be able to describe what happens when even a small portion of a solar module is shaded. Each student will be able to list two maintenance tasks for the surface of the solar module (e.g. keep clean, keep unshaded).

**Evaluation:** Informal, do as a class exercise by asking for a volunteer to describe what happens when just part of the solar array is shaded.

**OBJECTIVE 4:** The student can disconnect and reconnect the power system for routine maintenance at the on/off switch.

**Task:** Using the completed installation show the trainees the location of the on/off switch and have each student disconnect and then reconnect the system.

**Outcome:** Upon successful completion the student will be able to locate the on/off switch and operate the on/off switch and to disconnect and reconnect the power system.

**Evaluation:** Formal, each student will be required to disconnect the power by operating the on/off switches. Record the names of the trainees who have performed this function.

**OBJECTIVE 5:** Knowledge and practice using the solar module cleaning supplies and tool.

**Task:** Using the cleaning tool demonstrate the correct steps in cleaning the solar module including preparation of mild detergent and water mix, applying the mix and cleaning the glass until clean.

**Outcome:** Upon successful completion each student will demonstrate their skill in applying mix and use of the cleaning tool.

**Evaluation:** Formal, require each student to correctly apply mix and properly clean a solar module. Record the names of the trainees who have performed this function.

**OBJECTIVE 6:** The student can name the person(s) who they report problems with equipment including temperature alarms.

**Task:** Prior to training determine who the health worker is to report to when there are either vaccine-related concerns or equipment concerns. Communicate with the supervisors and note the date of the solar power installation and training, invite the supervisor and obtain their permission to instruct staff to report problems directly to them (or their designee) and get their contact information. List problems that the staff should report including vaccine refrigerator temperature alarms and equipment observations (e.g. power is not on during sunny days, plants are shading solar modules, etc.).

**Outcome:** Upon successful completion the student will be able to name the supervisor they must report problems to and provide their full contact information.

**Evaluation:** Informal, each student will be required to name the supervisor(s) they must report problems to and name two type of problems that must be reported.

**OBJECTIVE 7:** Accurately read and record the daily temperatures from the integrated 30 day temperature logger and then enter in a daily temperature log (two times per day). Describe when the refrigerator is sufficiently cooled and the cold storage is sufficiently charged (cooled) to store vaccine.

**Task:** Using the standard temperature log already used on site (or a copy of an approved temperature log sheet) have each trainee read the temperature on the CFD-50 SDD and then input the date, time, temperature and any other observation(s). Compare the recorded temperatures to the CFD-50 SDD instructions for when the refrigerator is ready to store vaccine.

**Outcome:** Upon successful completion, each trainee will correctly read the thermometer and accurately record date, time and temperature.

**Evaluation:** Formal, ask each student to read the present temperature on the display and then complete a “dummy” temperature log for the date, time and temperature presently displayed. Ask each student to write the number of the days the fridge must cool down before using the first time or after a prolonged period of no use. Record the names of the trainees who have performed this function correctly and answered the question correctly.

**OBJECTIVE 8:** Health workers will be required to periodically clean the interior and exterior of the CFD-50 SDD. Training will include this step to assure participants are practiced at carrying out this step.

**Task:** Following CFD-50 SDD instructions the trainee will clean the interior of the vaccine storage compartment.

Instructions (reprinted from CFD-50 SDD User's Manual)

**Cleaning maintenance:**

- a. Switch off the power supply to the CFD-50 SDD before cleaning. Wipe both inner and outer surfaces using a soft cloth dipped with neutral non-corrosive cleaning agent. Do not use any brushes, acidic or alkali detergents. Use a dry cloth to wipe clean surfaces. Do not use any organic solvents, hot water, detergents, or other harmful substances for cleaning
- b. Do not pressure wash nor use any hard scrub to clean the CFD-50 SDD in order to avoid water leakage to electric components and damage to the exterior
- c. Use warm water to scrub and clean the door gasket quarterly in order to maintain its flexibility and elasticity. Rub the door gasket with talcum powder to prolong its usage.
- d. Use a piece of paper to check if the door gaskets are still tight. Close the door on the paper and if the paper falls out the door latch needs to be adjusted or the gaskets must be replaced.

**Outcome:** Upon successful completion students have carried out the cleaning procedure per CFD-50 SDD instructions.

**Evaluation:** Informal, do as a class exercise and record names of each user who participates.

**OBJECTIVE 9:** Health workers will understand the operation of the Energy Harvesting Control (EHC).

**Task:** Describe energy harvesting: when the solar panel produces more energy than the fridge needs, the fridge makes it available at the outputs on the side of the refrigerator. This energy is not guaranteed, as it depends on the amount needed to keep vaccines cool and the amount being produced by the solar panel. Remind them that a clean solar panel produces more energy. Describe how to use: just plug in devices and they will take energy when it is available. Describe the LEDs: they show when energy is available.

**Outcome:** Upon successful completion each student will be able to describe what the EHC is for and how to use it.

**Evaluation:** Informal, do as a class exercise and record names of each user who participates.

## **5D ACCEPTANCE**

When an installation has been correctly completed, inspected, commissioned and the user has received training the installation is ready for the responsible health worker to accept the equipment and sign the acceptance form. The funding agency/buyer may have a specific Acceptance Form. See a sample form in **ANNEX E: Acceptance Form**.

## **PART 6: MAINTENANCE**

### **6A USER MAINTENANCE (ROUTINE / PREVENTATIVE)**

The health worker is responsible for day-to-day maintenance. Their main task is to monitor the MetaFridge CFD-50 SDD temperature for acceptable vaccine storage temperature of +2°C to +8°C. The health worker also will be responsible for keeping the CFD-50 SDD ventilation areas open and clean.

If the refrigerator is moved they will need to assure the CFD-50 SDD is in a secure, dry, level location out of sunlight and away from rain hazards.

Quarterly (or more frequently if Ministry of Health policies mandate) they will be responsible for assuring the solar array is clean, unshaded and undamaged. Solar array cable damage can occur from people, vehicles, large animals, small rodents and birds.

If equipment problems occur the health worker must know who to contact first (usually a supporting technician with cold chain experience).

For more details see both **Part 5C: Health Worker Training Outline** and **Annex I: Maintenance Checklist**.

### **6B TECHNICAL MAINTENANCE (ANNUAL / CORRECTIVE)**

The solar power system has no moving parts or controls.

Each year it is recommended to have a technician inspect the solar array, cable and grounding.

Look for shading, soiling and damage to the cable. Look for signs of corrosion and clean.

Check each electrical connection and tighten all grounding parts and tighten mechanical connections.

Train any new health workers in operations and maintenance and if necessary, retrain veteran health workers.

See the CFD-50 SDD MetaFridge User's Manual for appliance specifics.

## **PART 7: TROUBLESHOOTING AND REPAIR**

### **7A SOLAR POWER SYSTEM TROUBLESHOOTING**

Most solar arrays operate trouble-free for years with only routine, preventive maintenance. Solar direct drive (SDD) power systems are the simplest type of solar power system. There are no fuses, switches or controls between the CFD-50 SDD on/off switch and the solar array. There are two troubleshooting conditions that are possible – **no power** or **not enough power**. See CFD-50 SDD refrigerator troubleshooting for other possible troubleshooting conditions within the CFD-50 SDD.

**NO POWER:** If power is not available at the CFD-50 SDD its temperature will eventually rise and the green LED will not be lit when there is enough sunlight to start the compressor. If this occurs the most likely causes are:

- 1.) CFD-50 SDD “on/off” switch is in the “off” position; or
- 2.) Solar array is shaded or too dirty; or
- 3.) Solar array cable has an open circuit; or
- 4.) Solar modules are damaged; or
- 5.) Solar modules are missing; or
- 6.) Solar modules have failed.

**To troubleshoot when there is no power to the CFD-50 SDD:**

- Record CFD-50 SDD temperature, status of green LED and alarms and power icons on 30DTR display
- Check that CFD-50 SDD “on/off” switch is in the “on” position.
- Check solar array cable is securely connected to CFD-50 SDD cable (near the refrigerator).
- Check solar array cable is securely connected to solar array MC4 branch connectors (near the solar array).
- Carefully inspect the solar array, structure and cable to:
  - Check that solar array is clean.
  - Check that solar array is not shaded.
  - Check that solar modules are not damaged, broken or missing.
  - Check that mounting is secure, at correct tilt and orientation.
  - Check that wiring is not damaged and is secure.

If no apparent fault is found next test the solar array for acceptable Voc and Isc.

 Safety first! For review see **Annex F: Using Multi-meters.**

- Switch the “on/off” switch on the CFD-50 SDD to “off”.
- Disconnect both solar array cable MC 4 connectors from the CFD-50 SDD MC4 connectors near the refrigerator.
- Check that the polarity of the solar array cable and the CFD-50 SDD cable are correctly matched. If reversed, correct and test for CFD-50 SDD operation.
- Measure the solar array Voc.
- If zero (0) Vdc there is an open circuit. Find and repair.
- If the Voc is acceptable (e.g. at least 15 Vdc on hot day) then test for solar array Isc (short circuit current). Two technicians are recommended.
- Cover the solar array
- Set the multi-meter to read 20 Amp DC and position test leads in the solar array cable positive (+) and negative (-).
- Uncover the solar array and record amperage reading (and optionally record the solar radiation level with a hand-held solar meter).
- Cover the solar array.
- Remove the test leads now (this prevents dangerous direct current arcing that will damage both the MC4 connectors and the test leads).
- If the Isc is not acceptable repeat the Isc test with each solar module to determine which solar module(s) are faulty. Replace faulty solar modules.

**NOT ENOUGH POWER:** CFD-50 SDD is too warm but the compressor motor does operate for some on a sunny day. If this occurs the most likely causes are:

- 1.) Solar array is shaded or too dirty; or
- 2.) Power is being diverted for unauthorized use; or
- 3.) Solar module(s) cable has an open circuit; or
- 4.) Solar module(s) are damaged; or
- 5.) Solar module(s) are missing; or
- 6.) At times CFD-50 SDD “on/off” switch is accidentally in “off” position; or
- 7.) Solar module(s) have failed.

**To troubleshoot when there is not enough power to the CFD-50 SDD:**

- Record CFD-50 SDD temperature and status of green LED and alarms and power icons on 30DTR display
- Check that CFD-50 SDD “on/off” switch is in the “on” position.
- Check solar array cable is not connected to other devices.
- Check solar array cable is securely connected to CFD-50 SDD cable (near the refrigerator).
- Check solar array cable is securely connected to solar array MC4 branch connectors (near the solar array).
- Check that all solar modules are securely connected to the MC4 branch connectors.
- Carefully inspect the solar array, structure and cable to:
  - Check that solar array is clean.
  - Check that solar array is not shaded.
  - Check that solar modules are not damaged, broken or missing.
  - Check that mounting is secure, at correct tilt and orientation.
  - Check that wiring is not damaged and is secure.

If no apparent trouble is found, you will need to test the solar array for acceptable Voc and Isc.

 Safety first! For review see **Annex F: Using Multi-Meters with Solar Refrigerator Systems.**

- Switch the “on/off” switch on the CFD-50 SDD to “off”.
- Disconnect both solar array cable MC 4 connectors from the CFD-50 SDD MC4 connectors near the refrigerator.
- Measure the solar array Voc.
- If the Voc is acceptable (e.g. at least 15 Vdc on hot day) then test for solar array Isc (short circuit current). Two technicians are recommended.
- Cover the solar array
- Set the multi-meter to read 20 Amp DC and position test leads in the solar array cable positive (+) and negative (-).
- Uncover the solar array and record amperage reading (and optionally record the solar radiation level with a hand held solar meter).

-Cover the solar array.

-Remove the test leads now (this prevents dangerous direct current arcing that will damage both the MC4 connectors and the test leads).

-If the Isc is not acceptable repeat this test with each solar module to determine which solar module(s) are faulty. Replace faulty solar module(s).

## **7B SPARE PARTS – SOLAR POWER KIT**

Service providers are advised to carry a spare solar module, spare MC 4 branch connectors (+ and -), extra solar array cable (for extensions and for replacing damaged cable), spare theft deterrent fasteners and spare theft deterrent fastener tools.

No solar power kit spare parts are needed at the health facility.

## **PART 8: WARRANTY**

1. **Two-year warranty on the device, beginning on the date of shipment from Aucma, included at no extra cost.**
2. **Five-year warranty on energy harvesting components, included at no extra cost.**
3. Under warranty coverage, the manufacturer will repair or replace device components that have failed in the use of the device for its designed intent.
4. Warranty coverage does not include the following cases:
  - (1) *Damage caused by improper use or improper maintenance.*
  - (2) *Damage caused by attempted repairs done by a non-designated repair department.*
  - (3) *Damage caused by force majeure.*
  - (4) *Damage occurring after the warranty period has expired.*

## **PART 9: DISPOSAL AND RECYCLING GUIDE**

### **9A SOLAR POWER KIT COMPONENTS**

Solar modules have a 25-year power warranty. Typically, the solar module is warranted to provide 80% of its original rated power at year 25. There are reports of some solar modules still producing power after 30 years of continuous operation. Therefore, solar modules should be considered for redeployment for other uses once they are no longer useful electric generators for the CFD-50 SDD.

If the solar module no longer provides power (no voltage or no current) then contact local recycling authorities or the original solar module manufacturer (some have recycling programs to recover useful materials and capture any materials that could be dangerous, like lead solder).

Aluminum structure, copper wire and steel fasteners can be reused in some cases and all can be recycled.

## **REFERENCES and ACKNOWLEDGMENTS**

Annex A, Working Safely at Heights, and Annex F, Using Multi-meters with PV R/F Systems were provided courtesy of FGL/IM-PAHO and the Solar Electric Light Fund (SELF), which developed them as training materials for photovoltaic system installations.

We would also like to thank FGL/IM-PAHO and SELF for permission to use many of the photographs and graphics used in this manual.

Annex B, Site Assessment Worksheet, and Annex C, Installation Checklist, are from the World Health Organization. Permission to use them has been requested. The source document is:

*Introducing Solar-powered Vaccine Refrigerator and Freezer Systems: Guidance for managers in national immunization programmes.*

ISBN 978 92 4 150986 2

copyright WHO 2015

found at [www.who.int](http://www.who.int)



# ANNEX A: WORKING SAFELY AT HEIGHTS

Falls are the leading cause of injury and death in the construction industry. Solar installers that ignore safety have fallen through roof surfaces and have fallen off of roofs. Do not ignore safety!

All workers on the jobsite should receive training, from a competent person, with regard to the nature of fall hazards in the work place. Falls are the leading cause of injury and death in the construction industry. Each worker should be trained in the proper precautions and procedures for working at heights. This includes set up and use of ladders, scaffolds, and fall protection.

## Ladder Safety

Before use: Ladders must be kept in safe working order and used only for their designed purpose. Be aware of the safe load for which they were designed

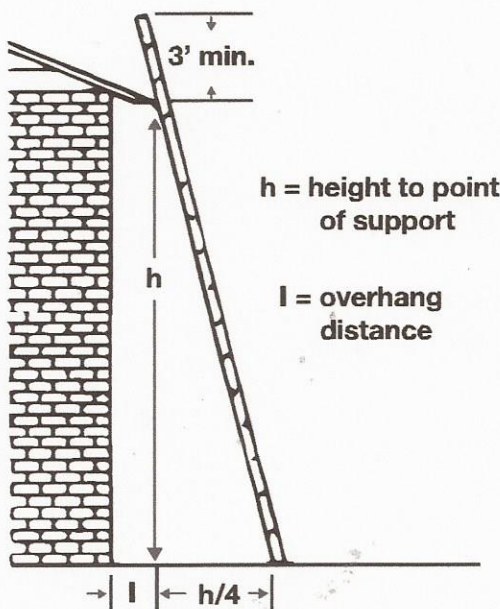


Figure A.1: Ladder placed safely for roof work.

and do not exceed their rated capacity. A ladder should be able to support 4 times the maximum load.

A competent person should always inspect a ladder before use to ensure that the rungs or steps are spaced evenly and safely attached to the sides of the ladder. Steps should be spaced 25 cm to 36 cm (10" to 14") inches apart. The ladder should be equipped with slip resistant feet. Defective ladders should be clearly marked as such and removed from service.

When placing a ladder for use, one should take the following precautions:

The bottom of the ladder should be placed on a stable, level ground or surface. Avoid slippery surfaces. The area around the top and bottom should be clear of obstructions and debris. The bottom of the ladder should be placed at a horizontal distance equal to 1/4 of its vertical height to the top support. The top of the ladder should extend at least one meter (39 inches) above the upper surface. The top of the ladder should be secured to prevent movement due to wind or jobsite activities. See Figure A.1.

When using the ladder, going up or down, take the following precautions:

Always face the ladder and grasp the ladder with at least one hand. Do not carry any load which will cause one to lose balance or not have a secure grip. Do not overreach and keep your body centers between the rails. Use a rope or multiple ladders to raise heavy or bulky equipment such as PV modules. See Figure A.2. Do not overreach and keep your body centers between the rails.

Additional precautions should be taken when using step ladders which are free standing:

Always be sure that the folding spreaders are properly set. Steps are typically found on only one side of the ladder. The braces found on the back side are usually not designed to support a person and should





Figure A.2: Use multiple ladders to lift bulky equipment such as PV modules.

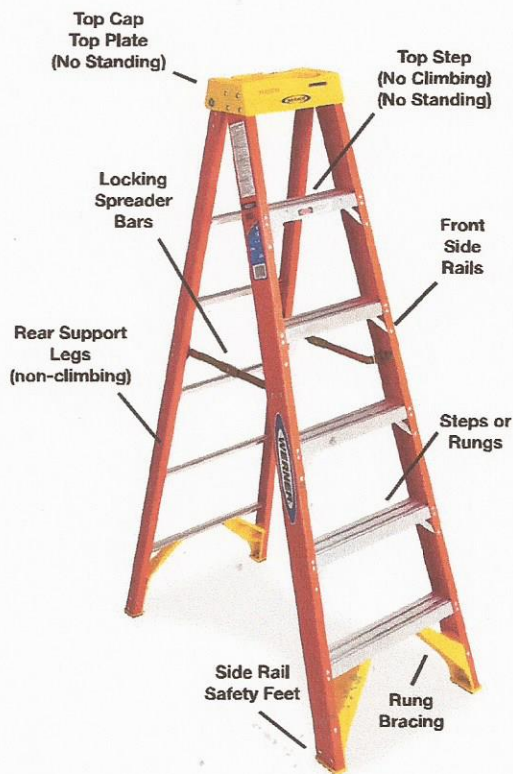


Figure A.3: Safe use of a step ladder

never be used for standing or climbing. Never step on the top two steps. See Figure A.3.

### Scaffold Safety

Pole mounts are difficult to install with ladders. Scaffolding provides a safe platform for working around the pole and the solar array structure. See Figures A.4 and A.5.

A competent person should always inspect scaffolding before being used by workers. Footings need to support the scaffolding in a level position capable of supporting the load. Adjustable footings are used to support the scaffold on uneven surfaces.

Scaffold platforms and planks must provide a stable surface with little deflection under load (not greater than 1/60 of the span) under load and be securely fastened to avoid shifting. The platform must be adequate to support 4 times the maximum intended load. Platforms should be a minimum of 45 cm (18") inches wide and free of clutter and debris. Spaces between planks and vertical supports should not be greater than 40 mm (1") inch. Scaffolds over 3 m (10') feet in height must be provided with fall protection; either by guard rails on all open sides and ends or personal fall protection for each worker

Scaffolding must be prevented from tipping if the ratio of height to base is 4:1 or greater. Braces or ties used to prevent the scaffold from tipping must be secured at the closest horizontal member to the 4:1 height.

More detail regarding scaffold safety may be found at the following website:

<https://www.osha.gov/Publications/osh3150.pdf>

### Fall Protection

Workers should receive fall protection training to recognize hazards and make proper use of fall protection precautions. Fall protection is required on roofs, ramps, and around openings or edges at elevations 1.8 meters (6' feet) or greater.

Fall protection may be handled in various ways. Choose the most appropriate method for your unique site conditions.

Personal Fall Arrest Systems entail a strong lifeline with stable and secure anchorage. The lifeline is





Figure A.4: The scaffold provides a safe, secure and level work surface. However this scaffold has an unsafe work platform.

attached to a harness worn by the worker. The fall protection system must prevent a worker from falling more than 1.8 meters (6'). Workers should inspect the lifeline for abrasions, cuts, frayed sections or any other damage. There are various anchor devices which may be used to attach to a roof structure. A well-positioned tree may also offer an opportunity for safe anchorage. See Figure A.6. A stretchable lanyard is typically used with the lifeline to cushion a fall. A "rope grab" is another device used by the worker to move the harness attachment up the lifeline to ascend the roof. The worker can release it by hand in order to descend. See Figure A.7. Harnesses may be approved by ANSI (American National Standards Institute) and /or OSHA (Occupational Safety and Health Administration).

More information regarding Personal Fall Protection may be found at the following website:

[https://www.osha.gov/SLTC/etools/shipyard/ship\\_breaking/ppe/general\\_ppe/fall\\_arrest\\_system.html](https://www.osha.gov/SLTC/etools/shipyard/ship_breaking/ppe/general_ppe/fall_arrest_system.html)

Other means of fall protection may consist of guard rails at edges of roofs and openings. Openings may also be covered with a structurally secure covering to prevent workers from falling through. Roof surfaces are often not strong enough to carry a worker and safe covering often must be added.



Figure A.5: Solar modules would be difficult and more risky to position with a ladder.



Figure A.6: The tree provides a safe and secure anchorage for attaching the lifeline.



Figure A.7: A worker's lifeline and harness.

## **ANNEX B: SITE ASSESSMENT WORKSHEET**

**Awaiting permission from WHO to include *Annex A* from the following document:**

Introducing Solar-powered Vaccine Refrigerator and Freezer Systems: Guidance for managers in national immunization programmes.

ISBN 978 92 4 150986 2

copyright WHO 2015

found at [www.who.int](http://www.who.int)

## **ANNEX C: INSTALLATION CHECKLIST**

**Awaiting permission from WHO to include *Annex E* from the following document:**

Introducing Solar-powered Vaccine Refrigerator and Freezer Systems: Guidance for managers in national immunization programmes.

ISBN 978 92 4 150986 2

copyright WHO 2015

found at [www.who.int](http://www.who.int)

## ANNEX D: METAFRIDGE CFD-50 SDD SOLAR POWER KIT COMMISSIONING REPORT

Site: \_\_\_\_\_ Address: \_\_\_\_\_

Date: \_\_\_\_\_ Solar Technician: \_\_\_\_\_

### Section 1: Solar Array

#### Solar array (general)

Quantity of solar modules \_\_\_\_\_ X \_\_\_\_\_ Watts per solar module = \_\_\_\_\_ solar array Watts

Orientation \_\_\_\_\_ Tilt angle \_\_\_\_\_ Unshaded? \_\_\_\_\_ If no, worst month loss = \_\_\_\_\_%

Polarity **WARNING:** Refrigerator will not operate with reversed polarity. It is protected from damage should polarity be reversed.

Polarity checked with voltmeter: \_\_\_\_\_

Positive (+) solar array cable MC4 connector fits into the CFD-50 SDD positive (+) \_\_\_\_\_

If no, STOP and correct polarity

#### Open circuit voltage

Specification Voc of the \_\_\_\_\_ solar module: \_\_\_\_\_ Voc at +25°C

Solar array cable voltage: \_\_\_\_\_ Voc at \_\_\_\_\_ °C estimated solar module temperature Short

#### circuit current

Specification Isc of the \_\_\_\_\_ solar module: \_\_\_\_\_ amps with 1000 Watts/m<sup>2</sup> solar radiation

Solar array amps: \_\_\_\_\_ Isc

Solar radiation measurement (optional): \_\_\_\_\_ Watt/m<sup>2</sup> \_\_\_\_\_ Time \_\_\_\_\_ Weather

#### Checklist Items:

\_\_\_ Solar Pathfinder checked for orientation and minimum unshaded time from 9AM to 3 PM.

\_\_\_ All cable and wire connections checked for tightness and professional installation – no exposed bare wire and no loose wire strands exposed for possible short circuit.

\_\_\_ All solar module and mounting structure fasteners are theft deterring.

\_\_\_ All solar module and mounting structure fasteners checked for tightness.

\_\_\_ All conduit fittings and fasteners checked for tightness.

\_\_\_ All building penetrations sealed weather tight.

## **Section 2: Grounding**

### Continuity and resistance:

Ground continuity from solar module to earth rod or reinforcement rod on roof: \_\_\_

Resistance from module frame to rod: \_\_\_\_\_ ohms.

\_\_\_ All ground wire connections checked for tightness.

\_\_\_ All fasteners checked for tightness.

## **Section 3: Interior work**

### Checklist Items:

\_\_\_ Refrigerator positioned per CFD-50 SDD installation instructions.

\_\_\_ Refrigerator level.

\_\_\_ Refrigerator filled to correct level with clean drinking water.

\_\_\_ Refrigerator positioned to prevent direct sunlight and to avoid rain or roof leakage.

\_\_\_ Cable entry secured.

\_\_\_ MC4 cable secured.

\_\_\_ MC4 connectors not allowed to touch the floor.

## **Section 4: CFD-50 SDD Start Up Procedure**

\_\_\_ Main battery connected to monitoring board (behind front panel).

\_\_\_ If optional telemetry module is installed, its battery has been connected.

\_\_\_ Power switch turned on.

\_\_\_ Interior vaccine chamber light is on when solar power is available.

\_\_\_ If solar power is available, compressor turns on about 5 minutes after power switch turned on Green LED illuminates.

\_\_\_ Health workers cautioned not to use CFD-50 until the display indicates that the vaccine chamber temperature is below 8 C and the 30 DTR display indicates at least 2 days of remaining autonomy/holdover. This might take more than two sunny days to achieve.

### **Section 5: Training**

\_\_\_ Local system operator trained in basic operation of system (including alarms, monitoring).

\_\_\_ Local operator instructed on solar array cleaning with cleaning tools provided.

\_\_\_ Cleaning tools left on site.

### **Section 6: Photographs**

\_\_\_ Solar module and Universal Mounting Structure.

\_\_\_ Universal Mounting Structure attachment to building, foundation or pole.

\_\_\_ Solar array cable.

\_\_\_ Ground wire.

\_\_\_ Ground connection to rod.

\_\_\_ Conduits (if used).

\_\_\_ Cable entry at building exterior.

\_\_\_ Cable entry at building interior.

\_\_\_ MC4 connections at CFD-50 SDD.

\_\_\_ CFD-50 SDD position.



**ANNEX E: SAMPLE Acceptance Document (MetaFridge CFD-50 SDD and Solar Power Kit)**

Please follow the MetaFridge CFD-50 SDD and Solar Power Kit instructions. Please install the unit and complete this form carefully after installation. This document will confirm the acceptance of the equipment.	
Model	
Code	
Beginning temperature	
Final temperature/weather condition	
<b>Installation Results (Please register problems encountered)</b>	
<b>Element</b>	<b>Record</b>
Solar array connected (Yes / No)	
Temperature displayed by the device (Yes / No)	
Temperature of the vaccine storage chamber decreased (Yes / No)	
Weather conditions since commissioning	
Training provided (Yes / No)	
<b>Product Photos (Including the solar module)</b>	
Installation Technician	Signature:
Health Worker	Signature:
<b>Date</b>	Time:

# ANNEX C: USING MULTI-METERS WITH PV R/F SYSTEMS

---

## 1: MULTI-METERS

A multi-meter is one of your most important tools. Multi-meters are used to measure voltage and amperage as well as to test for polarity and continuity. Some multi-meters also measure temperature.

Installers must be thoroughly familiar with the use of the meter. Since each meter is manufactured slightly differently, read the instructions that are included with your meter.

Remember that most multi-meters are battery operated and have internal fuses so be prepared with spare fuses and a replacement battery.

This section of the handbook details specific measurements for PV R/F. The measurements shown here are often taken with the PV R/F parts before traveling to the installation. The examples given below are for digital meters.

## 2: POLARITY

The meter can be used to determine the polarity of battery terminals, PV module terminals and wiring. To measure polarity connect the red meter lead to "V" and connect the black meter lead to "COM". Set the meter to read DC voltage at a scale that is higher than the voltage you expect to read.

Measure the part being tested and read voltage noting whether a negative sign (-) was displayed ahead of the voltage. A negative reading indicates that the polarity of the placement of meter leads is reversed from the polarity of the circuit being measured. (See Figure C.1). Switch the position of the meter leads and reread voltage until correct polarity is found. (See Figure C.2)

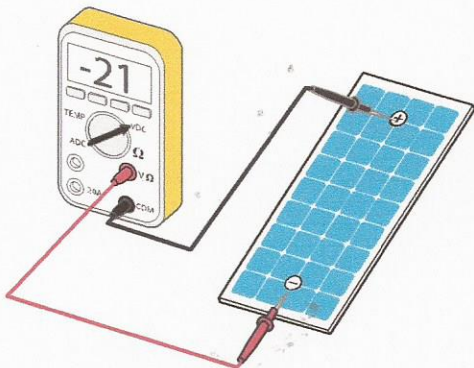


Figure C.1: Testing polarity (reversed).

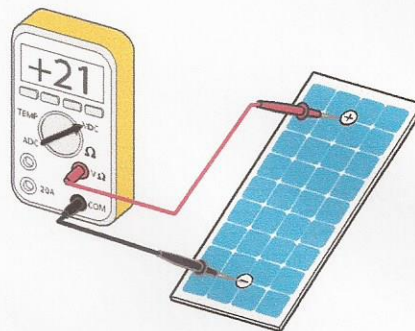


Figure C.2: Testing polarity.



### 3: CONTINUITY

The meter can be used to test if a fuse is good, if switches are working and if wiring circuits are continuous. To measure resistance connect the red meter lead to "Ω" and connect the black meter lead to "COM". Set the meter to read resistance "Ω".

A closed circuit has continuity and is shown on the meter as having little or no resistance to electricity flow. An open circuit will show a very high resistance. For example, a blown (no longer useful) fuse will measure as an open circuit (as shown in Figure C.3). A working switch will show little resistance when the switch is closed and will show very high resistance when it is opened

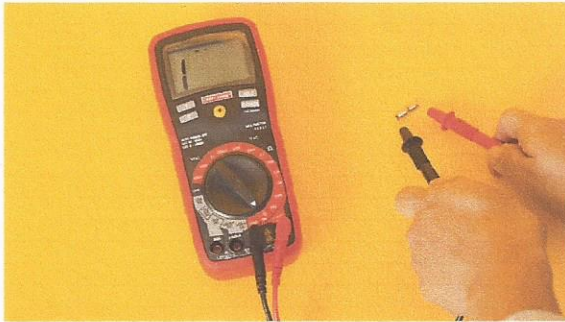


Figure C.3: Meter measuring the resistance of a burnt fuse (an open circuit).

### 4: VOLTAGE

The meter can be used to measure system operating voltage and the open circuit voltage of both batteries and PV modules. To measure voltage connect the red meter lead to "V" and connect the black meter lead to "COM". Set the meter to read DC voltage at a scale that is higher than the voltage you expect to read.

An open circuit voltage measurement can be compared with a manufacturer's specification to find out if the solar module meet specification. Do this before travel to insure the module is acceptable or if a battery needs to be recharged.

To test for open circuit voltage (Voc) of a PV module, first locate the module specification. All solar modules have a specification sheet and most modules also have a specification sticker on the back of the module. See Figure C.4.

The module should be placed in the sun and measured



Figure C.5: Measuring solar module open circuit voltage. If the solar module has a standard test rating of 21.8 Voc (at +25°C) its Voc will fall about 1 Volt if the solar module is about 10 °C hotter.

Model Number : SLP090-12	
Nominal Maximum Power (P <sub>max</sub> )	90W
Optimum Operating Voltage (V <sub>mp</sub> )	17.6V
Optimum Operating Current (I <sub>mp</sub> )	5.11A
Open-Circuit Voltage (V <sub>oc</sub> )	21.8V
Short-Circuit Current (I <sub>sc</sub> )	5.51A
Maximum System Voltage	600V <sub>dc</sub>
Maximum Series Fuse Rating	10.0A
All technical data at standard test condition (E=1000W/m <sup>2</sup> TC=25°C Am=1.5)	
Maximum Temperature	85°C
Application	Class A
Fuse Rating	Class C
<p>Note: Prior to installation, please refer to the bypass diode wiring instructions in the instruction manual. For field connections, use 12AWG wires, insulated for a minimum of 90°C, rated for wet conditions and resistant to salt water corrosion (annealed copper wire only).</p> <p>• Class 1, Division 2, Groups A, B, C and D, T3, ambient temperature -40 to 85 degree C.</p> <p>• WARNING - EXPLOSION HAZARD - DO NOT DISCONNECT WHILE CIRCUIT IS LIVE UNLESS AREA IS KNOWN TO BE NON-HAZARDOUS.</p> <p>• AVERTISSEMENT - RISQUE D'EXPLOSION - NE PAS DÉBRANCHER TANT QU'IL Y A DU COURANT. EST SOUS TENSION A MOINS QU'IL NE S'AGISSE D'UN EMPLACEMENT NON DANGEREUX.</p>	
<p>WARNING</p> <p><b>ELECTRICAL HAZARD</b></p> <p>This solar module produces electrical voltage when exposed to sunlight or intense artificial lights. Proper precautions associated with electrical power systems must be taken when handling and installing this product.</p> <p>PLEASE READ THE INSTRUCTION MANUAL FOR MORE INFORMATION PRIOR TO INSTALLATION.</p>	
<p>Class 1, Division 2, Groups A, B, C and D                      Conforms to UL STD No. 1703, Canadian UL CORD-C1703</p>	

Figure C.4: Solar module label with electrical specifications based on standard test conditions at +25°C.



immediately since voltage will drop as the module becomes warmer. Set the meter and position the test leads as shown in Figure C.5.

The open circuit voltage of a battery can be misleading if the battery is not first cycled under a load to remove the surface charge which will give a higher voltage reading. To measure voltage, disconnect battery from any charger and all loads. See Figure C.6. Set the meter to the DC voltage scale that includes the voltage you expect to read. Connect the positive lead to the positive terminal and connect the negative lead to the negative terminal and record the voltage. Compare the measured voltage with the battery manufacturer's specification. A 12 Vdc battery that is fully charged will measure at least 12.6 Vdc (open circuit). Batteries that have been shipped may require an initial charge to bring voltage up to specification. Batteries connected to a complete PV RF system in operation will measure within the full range of the system control specifications (e.g. 11.6 to 13.8 Vdc for sealed batteries or 11.5 to 14.4 Vdc for flooded batteries).

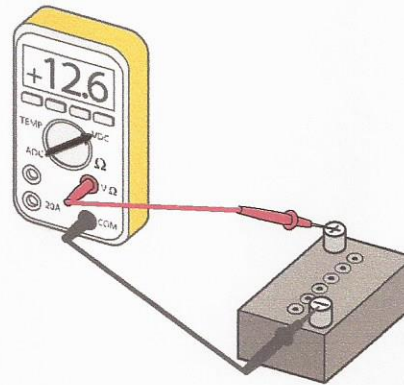
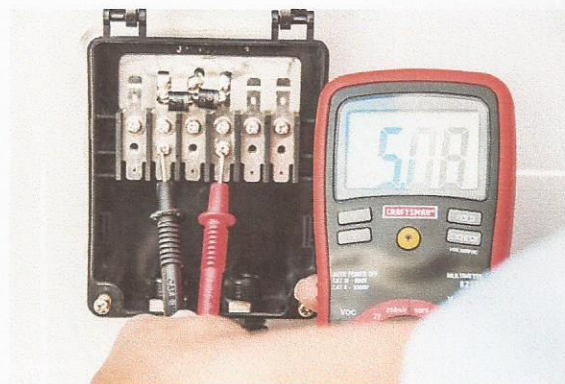


Figure C.6: Measuring battery open circuit voltage.

**5: CURRENT (AMPS)**

Amps can be measured when a solar module is in sunlight but is not connected to the PV RF. This is called short circuit current (Isc) and measurement of Isc does not damage the solar module. Amps can also be measured when the PV RF is fully connected and operating. To measure solar power system current connect the red meter lead to "10A" or "20A" and connect the black meter lead to "COM". Set the meter to read DC amps at a scale that is higher than the amps you expect to read.



If your meter is rated to measure at least 10 amps DC you can use it to measure the short circuit current of the PV module. To test for short circuit (Isc) of a PV module, first locate the module specification. All solar modules have a specification sheet and most modules also have a specification sticker on the back of the module. See Figures C.4 showing a 90 Watt module sticker with standard test conditions rating of 5.11 amps (Isc). Standard test condition is 1000 Watts/m<sup>2</sup> which is strong sunlight on a clear day at noon.

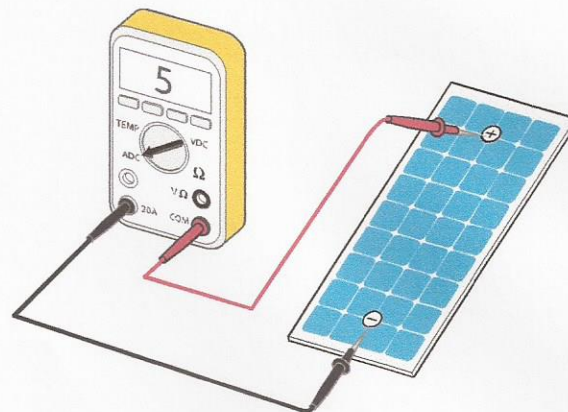


Figure C.7: Measuring PV module short circuit current

The amount of amperage produced by a PV module is directly related to how strong the sun is at the time of measurement. A solar module with an Isc rating of 5 amps at 1000 watt/m<sup>2</sup> would only measure about 2.5 amps (Isc) if the sunlight was 500 Watts/ m<sup>2</sup>. Measure the short circuit current and compare to the manufacturer's specification (see Figures C.4 and C.7).



To accurately compare you need to know the solar radiation at the same instant that you measure the solar module short circuit current. Handheld solar meters are not essential but are recommended for technicians that will be responsible for many installations. See Figure C.8 showing how to use a hand held solar meter.

A solar array is usually made up of more than one solar module. The current of a solar array with more than one solar module connected in parallel may be more than 10 amps. Not all multi-meters can measure the solar array current if over 10 amps. Some multi-meters are capable of measuring 20 amps DC. Another method of measuring higher DC amps is with a clamp-on ammeter (see Figures C.9 and C.10). These meters can measure high DC amperage. Use a clamp-on ammeter to measure higher DC amps and/or when you need to measure operating amperage without interrupting the circuit. Figure C.9 shows two clamp-on ammeters with one meter measuring the solar array charging amps (20 amps) and the other meter measuring the operating compressor amps (4 amps).



Figure C.8: Hand held solar meter measuring strong sunlight (982 Watts/m<sup>2</sup>). The simultaneous solar module current was measured as 5.08 amps (Isc). This is acceptable because 5.08 amps (Isc) is nearly equal to the 5.11 amps (Isc) reported on the solar module specification (measured at standard test condition solar radiation of 1000 Watts/m<sup>2</sup>).

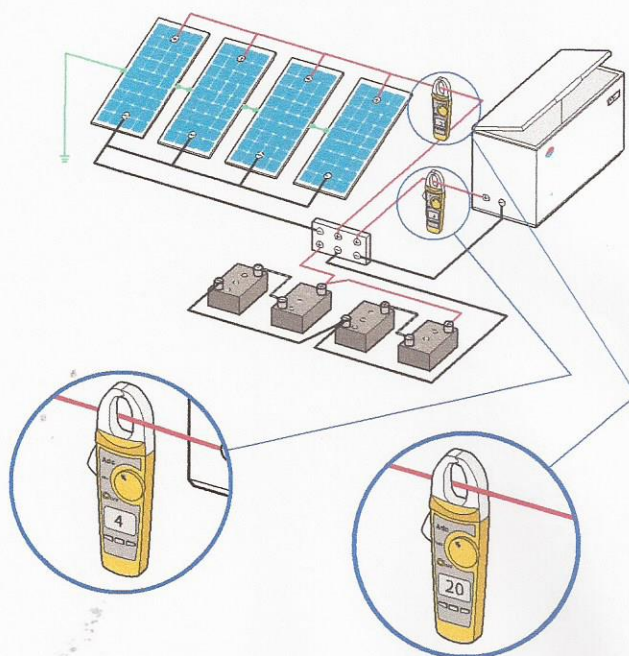


Figure C.9: Measuring DC amperage without interrupting an operating circuit.

## 6: RESISTANCE

The meter can also be used to measure the resistance of various components including the compressor connection pins, resistors, diodes and electronic thermostats.

Measure the resistance of an electronic thermostat sensor and then compare the measured resistance to manufacturer specification for a specific temperature set point.

Resistors are sometimes added to compressor controls to set compressor speed and the meter can confirm the resistance is correct for the desired speed.

To measure resistance connect the red meter lead to " $\Omega$ " and connect the black meter lead to "COM". Set the meter to read resistance " $\Omega$ ".

Solar modules have bypass diodes and their resistance can be measured to determine if they are good. Check the manufacturer specification for resistance values.

Solar array to earth ground resistance is also measured to confirm acceptable grounding has been installed. See Figure C.11.



Figure C.10: Clamp on ammeter.

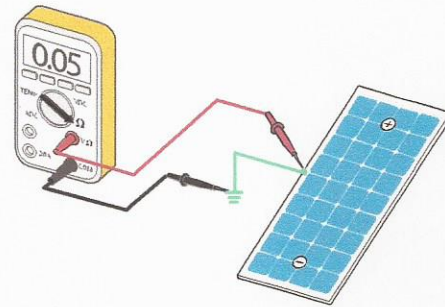


Figure C.11: Measuring the resistance of solar module frame/solar array structure to earth ground connection.

## ANNEX G: Health Worker Quiz

Name \_\_\_\_\_ Location \_\_\_\_\_ Date \_\_\_\_\_

Contact information \_\_\_\_\_

Each health worker can earn a Certificate of Completion for the solar vaccine refrigerator training class. For certification each worker will be required to participate in all of the training activities listed below and pass the test below. To pass you will need to earn at least 10 points (out of 15).

Each activity you participate in will earn one (1) point (Instructor will mark when you complete each)

1. Name the main components of the entire system \_\_\_\_\_
2. Lock/unlock refrigerator \_\_\_\_\_
3. Turn on/off solar power system \_\_\_\_\_
4. Solar module cleaning \_\_\_\_\_
5. Refrigerator cleaning \_\_\_\_\_
6. Read and record refrigerator temperature \_\_\_\_\_

Circle the correct answer to these questions:

- 7.) The acceptable temperature range for vaccine storage in a refrigerator is a.)  $-20^{\circ}\text{C}$  to  $+20^{\circ}\text{C}$  b.)  $0^{\circ}\text{C}$  to  $+10^{\circ}\text{C}$  c.)  $+2^{\circ}\text{C}$  to  $+8^{\circ}\text{C}$
- 8.) A green light means the refrigerator is a.) switched on and the compressor is running b.) temperature is acceptable c.) freezing the vaccine d.) too hot
- 9.) If the thermometer display is off it means: a.) the refrigerator or the solar array need troubleshooting b.) light level is too low to read the thermometer c.) it is too hot d.) it is too cold
- 10.) Which of these can reduce or stop solar array power? A.) animal damage b.) plant shading c.) dirty solar modules d.) all of these

Complete the answer to each question.

- 11.) If the refrigerator needs special attention that you cannot provide who should you contact first?  
\_\_\_\_\_

- 12.) Name one child safety concern with refrigerators.  
\_\_\_\_\_

- 13.) Was the vaccine refrigerator made to cool food or beverages? \_\_\_\_\_

- 14.) Is it normal for the compressor to go off when a cloud passes by? \_\_\_\_\_

- 15.) Every day you should check the CFD-50 SDD for \_\_\_\_\_

BONUS (1 point) How many days does the CFD-50 SDD need to initially cool down? \_\_\_\_\_ days

**Annex H**  
**MetaFridge CFD-50 SDD USER TRAINING CHECKLIST**

Date	
<b>Part 1: Product Profile</b>	
Product Name	
Version	
Serial Number	
<b>Part 2: Customer Profile</b>	
Customer Name	
User Type	<input type="checkbox"/> HCW (specify) <input type="checkbox"/> Technician
Training Mode/Type	<input type="checkbox"/> Centralized <input type="checkbox"/> On site
Location/Site	
Facility Type	
<b>Operation</b>	
<input type="checkbox"/>	General guidelines and physical handling of the fridge prior to using it
<input type="checkbox"/>	Components of SDD, solar array, and interconnections.
<input type="checkbox"/>	How to store Vaccines – no specific vertical arrangement required
<input type="checkbox"/>	How to use the storage trays, and shelves, adjustable shelf location and stackable trays
<input type="checkbox"/>	SDD-specific operation <ul style="list-style-type: none"> <li>● Compressor and fan operation depend on availability of solar power, and that changes throughout the day and with weather.</li> <li>● Shading the array greatly reduces power availability. Shading can be from buildings, plants, or dust.</li> <li>● Location of power switch</li> <li>● Operation from AC power as well as solar – switching is automatic; both can be connected. It preferentially uses solar, only using AC if necessary.</li> </ul>
<input type="checkbox"/>	How to translate LED lights – Green LED is compressor Run, flashing RED is alarm
<input type="checkbox"/>	Manipulation of the 30-DTR and information display screen <ul style="list-style-type: none"> <li>● Reading and interpretation of current temperature</li> <li>● Holdover time</li> <li>● Power availability indicator</li> <li>● Alarm and temperature history</li> <li>● USB interface (plug on side of fridge) to access historic temperature history</li> <li>● Highlight that the buttons do not need hard presses but rather soft touch</li> </ul>
<input type="checkbox"/>	How to remotely monitor temperature – Highlight that remote data will be coming and available
<input type="checkbox"/>	How to silence an alarm – press any of the buttons
<input type="checkbox"/>	Energy Harvesting <ul style="list-style-type: none"> <li>● How to use the automotive socket, USB charging ports, and flexible power output.</li> <li>● Meaning of socket LEDs – power is presently supplied to them, and order of turning on</li> <li>● Harvested energy is not guaranteed, it depends on the needs of the fridge and solar power conditions.</li> </ul>
<b>Maintenance</b>	



<input type="checkbox"/>	<p>How to perform daily maintenance</p> <ul style="list-style-type: none"> <li>● Checking temperature daily (2 - 8°C)</li> <li>● Checking the Autonomy/Holdover time</li> <li>● Checking the power availability</li> </ul>		
<input type="checkbox"/>	<p>How to perform monthly maintenance</p> <ul style="list-style-type: none"> <li>● Cleaning the vaccine chamber</li> <li>● Removing any obstacles around the CFD-50 that prevent airflow</li> <li>● Cleaning dust from the sides of the fridge</li> <li>● Cleaning of the inner and outer door gaskets</li> <li>● Inspection of the gaskets for; <ul style="list-style-type: none"> <li>○ cracks between rubber</li> <li>○ gaps between gaskets and door when closed</li> </ul> </li> </ul>		
<input type="checkbox"/>	<p>How to perform quarterly maintenance (or more frequently if policies mandate)</p> <ul style="list-style-type: none"> <li>● Check solar array for dust and clean if necessary</li> <li>● Check solar array for shading by plants, and prune if necessary.</li> <li>● Check cable for damage.</li> </ul>		
<input type="checkbox"/>	<p>How to perform annual maintenance</p> <ul style="list-style-type: none"> <li>● Inspection of water level</li> <li>● Refilling if water level is below the bottom of the fill tube</li> </ul> <p><b>NB;</b> Maintenance instructions are also located on the information label on front of the CFD-50 and in user manual</p>		
<b>Customer</b>		<b>Trainer</b>	
<b>Name</b>		<b>Name</b>	
<b>Function</b>		<b>Function</b>	
<b>Signature or Stamp</b>		<b>Signature</b>	



## ANNEX I: Maintenance Checklist

### MetaFridge CFD-50 SDD and Aucma Solar Power Kit

#### Daily Maintenance:

- Check thermometer on refrigerator for acceptable vaccine temperature (+2°C to +8°C).
- Record vaccine refrigerator temperature on Daily Temperature Record
- Check refrigerator is clean and has air circulation around all sides.
- If there is a problem you cannot solve report the problem to your supervisor.
- Other (e.g. report error messages) \_\_\_\_\_

#### Monthly Maintenance:

- Disconnect power.
- Clean refrigerator (inside, outside, ventilation grills and external condensers at the back of the unit).
- Clean and check door gaskets (inner and outer).
- Clean solar array (only if dusty, dirty and/or mold is growing on it).
- Reconnect power.
- Check solar array for shading from plants. Trim plants that shade solar array.
- Check solar array for other shading (e.g. new construction). Report to supervisor.
- Check wiring for signs of damage (animals, accidents). Report to supervisor.
- Other \_\_\_\_\_

#### Annual Maintenance:

- Inspect CFD-50 SDD water level. Top off with clean drinking water, if needed.
- Request technician to tighten all electrical connections.
- Request technician to tighten all mechanical connections.

## **ANNEX J: Installation Tool Checklist**

The tools most often used during a CFD-50 SDD installation are listed below. Because remote sites seldom have AC (alternating current electricity supplied by a generator or utility) no tools requiring AC have been listed. Instead hand tools and some battery operated tools have been listed. If you require AC tools you may need to add a generator, fuel and spare parts to your list.

Each installation is slightly different and this list does not contain every possible tool needed. Some tools are required at all installations and these are listed as "Required tools". All tools should be inspected and tested before packing for an installation.

There is no better way to have all the tools you will need than to visit the site and make your tool list for each job. Use the items below to make a list for each site.

### **Required Tools:**

- First aid kit
- Safety eyeglasses
- Tool belt
- Multi-meter (quantity =2, minimum 10 amps DC, 20 amps DC recommended)
- Spare batteries for the multi-meters
- Claw hammer
- Drills (battery)
- Drill bits for wood, metal and masonry
- Saw (metal, wood and plaster)
- Tape measure
- Pencils and paper
- Knife
- Portable light (battery)
- Level
- Solar siting device
- Compass
- Inclinometer
- Wire brush
- Wire cutters
- Caulk gun
- Screwdriver sets (slotted and Phillips head)
- Sledge hammer
- Wrenches (per fasteners)
- Socket set
- Theft deterrent fastener tools
- Lockable tool box

Other commonly used tools not required at all sites include:

- Ladder and/or scaffold
- Rope
- Solar radiation meter
- Thermometer
- Framing square
- Combination square
- C clamps

- Drill bit extender
- Step bit
- Expansion bit
- Masonry bits
- Wood boring bits
- Round file
- Rasp file
- File holder
- Soft bristle brush
- Center punch
- Offset snips
- Wood chisel
- Nail set
- Chalk line
- Slip joint pliers
- Locking pliers
- Adjustable pliers
- Long nose pliers
- Wire strippers
- Lineman pliers
- Nutdriver set
- Open end wrenches
- Adjustable wrench
- Pipe wrenches
- Pry bar
- Shovel
- Pick
- Masonry trowel
- Nail puller
- Tape measure (30 meter/100 feet)
- Tool belts
- Locking tool box